

STANLEY
Engineered Fastening



HELI-COIL[®]
Wire Insert Systems



HeliCoil[®]



HeliCoil® Inserts

Heli-Coil Inserts have evolved since their inception in the 1930's and now include the complete range of both tanged and tangless free running and screw-locking wire insert systems.

Today Heli-Coil delivers a vast array of high quality inserts and installation tools designed to meet the needs of the industry's ever demanding designers and manufacturers. Inserts are available in a variety of materials and special coatings. With Heli-Coil threads, tapped holes are strengthened and thread life is dramatically increased.

Heli-Coil Inserts are The Original.

Manual Tools

Heli-Coil offers a complete line of tooling together with a full array of STI taps, gages and tang break-off tools.

For production runs, prototype work, salvage and repair, Heli-Coil offers a range of installation and extraction tools for both tanged and tangless inserts to complete the needs of your application.



Power Tools

For higher volume production, we offer both electronic and pneumatic power inserting tools.

Heli-Coil power tools can be adapted to assembly stations, rotary tables and transfer lines for rapid installation. Our application engineers are always available to assist in installation techniques and special tooling.

Quality

Our strict quality programs ensure that we meet the latest industry standards of ISO/TS 16949:2002, ISO 14001:2004, AS/EN/JISQ9100 Rev C and ISO 9001:2008. A comprehensive Business Management System elevates our quality levels well above our competitors.



Table of Contents

Insert Information & Specifications	Page
Introduction to Heli-Coil Products	2
Types of Inserts, Tanged and Tangless	4
Tanged and Tangless Inserts, Features & Benefits	5
Locking Inserts, Feature and Benefits	6
» Screw-Locking Inserts	6
» Hi-Torque Inserts	6
» Stud-Lock Inserts	6
Industry Standards and Specifications	7
Coatings & Platings	8
Insert Materials	9
Torque Data for Screw-Locking Inserts	10
Design Data and Guidelines	11
» Assembly Strength	
» Corrosion Protection	
Tanged Inserts, Part Numbers and Specifications, inch & metric	12-13
Tangless Inserts, Part Numbers and Specifications, inch	14
Tangless Inserts, Part Numbers and Specifications, metric	15
<hr/>	
Insert Installation	
Assembly Design	16
Engineering Data	17
» Drilling, Countersinking, Tapping, Gaging	
Drilling Data, inch & metric	18-19
Tapping Data, inch & metric	20-21
STI Tap Part Numbers, inch	22
STI Tap Dimensions, inch	23
STI Tap Part Numbers, metric	24
STI Tap Dimensions, metric	25
Gages, inch	26
Gages, metric	27
<hr/>	
Installation Tooling	
Types of Tools, Tool Service	28
Hand Installation Tools	29
Power Installation Tools, inch & metric	30-32
Tang Removal Tools	33
Tangless Tools, inch	34
Tangless Tools, metric	35
Tool & Tap Selection Guide, inch	36
Tool & Tap Selection Guide, metric	37
Thread Repair Kits and Master Sets	38

The descriptions, specifications and other claims made with respect to the products featured in this catalog are made as of the date of printing. STANLEY Engineered Fastening retains the right to discontinue production or make improvements or other changes to any of its products without notice.

Tangless® is a registered trademark of Advanex, Inc. (JP) used under license.



Free Running Insert



Screw-Locking Insert

Types of Inserts

There are two styles of Heli-Coil inserts. The standard or **FREE RUNNING** insert which provides a smooth free-running thread; and **SCREW-LOCKING** which provides self-locking torque on the male member by a series of "chords" on one or more of the insert coils. They are both available in Tanged and Tangless; Inch and Metric series.

(Note: Inch series Screw-Locking inserts are dyed red for identification.)

Heli-Coil inserts are precision formed coils of extremely hard, diamond shaped 304 stainless steel. When installed into an STI tapped hole, they provide permanent conventional 60° internal screw threads. This assembled insert accommodates any standard bolt or screw as per MIL-S-7742 and AS8879 (UNJ controlled root radius). Inserts can be custom made in all materials listed on p. 9.

Heli-Coil tanged inserts are larger in diameter before installation than the tapped hole. During installation, the inserting tool applies torque to the tang reducing the diameter of the leading coil permitting it to enter the tapped thread. After installation, each high tensile coil of the insert expands outward with a spring-like action permanently anchoring the insert.



Diamond Shaped Wire

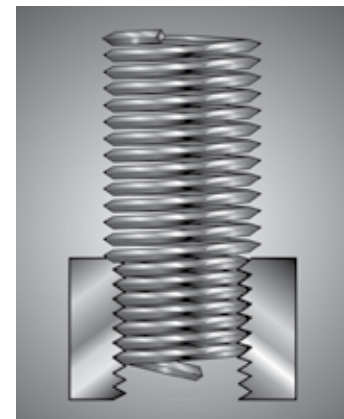

Illustration of the Retention Principle

Tanged Size Range:

- » UNC #1 through 1-1/2
- » UNF #2 through 1-1/2
- » Metric Coarse M2 through M39
- » Metric Fine M8 through M39

Inserts are also available in UNEF, UNS, 8UN, 12UN, 16UN, Spark Plug and Pipe Thread.



Tangless Free Running Insert

Tangless inserts eliminate the need for tang break-off and retrieval. Since no loose tangs are left behind, they become the solution when Foreign Object Debris (FOD) cannot be present in critical applications. Loose tangs can potentially cause damage and result in the need for costly repairs.

Tangless inserts are manufactured using the same materials as standard inserts and provide the same superior performance characteristics. They are available in Free Running and Screw-Locking and in inch and metric series, coarse and fine.

Tangless Size Range:

- » UNC #2 through 1/4
- » UNF #10 and 1/4
- » Metric Coarse M2.5 through M6

FEATURES & BENEFITS

Heli-Coil inserts provide a positive means for protecting and strengthening tapped threads in any material. The unique design features of the insert offer many benefits.

Stronger Assemblies

Tapped threads are strengthened because the inherent flexibility of the insert provides a more balanced distribution of dynamic and static loads throughout the length of thread engagement. This flexibility also compensates for variation in lead and angle error allowing each coil to carry its share of the load.

No Thread Wear

Thread life is dramatically increased even after repeated assembly and disassembly because the insert hardness and surface finish practically eliminate erosion of the thread form due to frictional wear.

Corrosion Resistance

Under normal environmental conditions, Heli-Coil inserts minimize galvanic action within the threaded assembly because of their superior corrosion resistance.

Design Flexibility

Bolt tensile strength can be balanced against parent material shear strength, assuring bolt failure rather than parent material damage. Five insert lengths are available in each thread size.

Eliminate Stress

Virtually no stress is introduced into the parent material because there is no staking, locking, swaging or keying in place – the outward spring-like action of the insert holds it in place.

Minimize Space & Weight

Heli-Coil inserts allow the use of smaller bosses and flanges than any other insert. Heli-Coil inserts can generally be incorporated into existing designs, where no other provision has been made for an insert, without increasing boss size.

Minimize Total Cost

Cost savings abound. Lower insert cost, lower installation cost and Heli-Coil inserts provide design flexibility by allowing a wide choice of parent materials while maintaining maximum threaded assembly strength.

True Clamping Torque

Maximum clamping action and bolt tension are assured with minimum wrench torque because of the mirror-smooth surface finish of Heli-Coil inserts.

Wide Temperature Range

Heli-Coil stainless steel inserts can be used in temperatures ranging from -320°F to +800°F.

Quality & Reliability

Stringent Quality Assurance and Engineering Standards are rigidly enforced in all phases of the manufacturing process. This assures integrity of your product design.

High Volume Production

Heli-Coil inserts are available mounted on plastic strips and wound onto reels (500 or 1000 inserts per reel). With power installation tooling, use of strip feed inserts will substantially increase installation rates by minimizing handling.

Universal Acceptance

Heli-Coil Standard and Screw-Locking Inserts are the original – and have an extensive background of tension, torque, shear, vibration and fatigue tests conducted by American industry's leading companies as well as the U.S. Military. Successful applications in the fields of aviation, electronics, industrial, automotive and military equipment provide a wealth of experience and confidence in the performance and reliability of Heli-Coil inserts.

Custom Design Services

In addition to the benefits listed above, Heli-Coil provides a wide range of support to solve fastening problems. This design catalog is one of them. The following pages are presented in a manner to make it easy to "design-in" Heli-Coil inserts to take advantage of the extraordinary benefits they provide.

Additionally, our Sales Engineers, Applications Engineers and Design Engineers are available for consultation for specific designs. When the product gets to the manufacturing phase, our extensive experience in production tooling and installation techniques ensures that you can indeed make your product better with Heli-Coil inserts.

LOCKING INSERTS

Heli-Coil offers three types of Locking Inserts for multiple applications.

Screw-Locking Inserts

- » A resilient locking mechanism that grips the bolt and prevents it from loosening under vibration or impact.
- » Repeated assembly and disassembly without appreciable loss of positive self-locking torque.
- » Savings in space, weight and money, through the elimination of lock wiring, lock nuts, lock washers, chemical compounds, plastic pellets/patches and/or other locking mechanisms.
- » Inch inserts dyed red for easy identification.
- » Meets **NASM8846, MA1565, NASM21209, MA3329, MA3330, MA3331.**

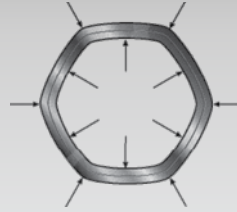

The locking action is achieved by one or more of the insert coils having a series of straight segments or “chords”.

When the bolt enters the “grip” coil, these chordal segments flex outward, creating pressure on the bolt. The pressure is exerted between the flanks of the bolt thread to establish an extensive positive and consistent self-locking torque over more cycles than any other prevailing torque mechanism.

Hi-Torque Inserts

- » Similar to Screw-Locking but with higher prevailing torque which compensates for reduced friction in highly lubricated applications.
- » Ideal for higher vibration applications.
- » Approximate 40% increase in prevailing torque levels.
- » Available in #10 through 3/8" UNF only.
- » Meets **AS1394, AS3094, AS3095, AS3096, AS3097.**



Stud-Lock Inserts

- » Highest prevailing torque insert available.
- » Enables use of threaded rod for space-saving stud applications.
- » Allows for any class fit of threaded rod.
- » Eliminates inconsistencies caused by interference-fit studs.
- » Available for both straight and step studs, #10 through 1/2" UNC and UNF.
- » Meets **AS1229, AS3080, AS3081, AS3082, AS3083.**



LOCKING FEATURES & BENEFITS

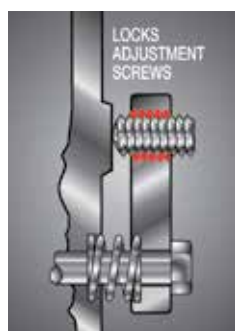
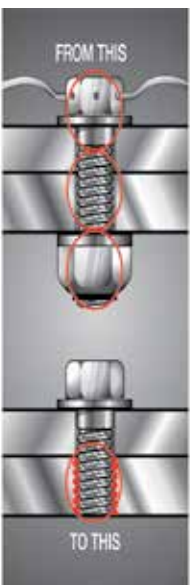

Locks Adjustment Screws. This simple design allows permanent, positive adjustment of screws in any position. Secure against vibration or impact.

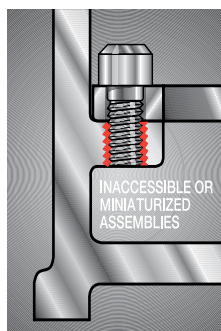

Inaccessible or Miniaturized Assemblies. Heli-Coil Screw-Locking inserts permit the installation of the lock from the front or top. No blind fumbling for assembly of lock washers or lock nuts behind or underneath.



Lock Set Screws. Positively locks assembly against loosening at desired adjustment. Protects threads against stripping under high torque. Permits use of light housing materials.

INDUSTRY STANDARDS

Heli-Coil inserts and tooling comply with the following Standards and Specifications:

NASM122076 thru NASM122275

Insert, corrosion resistant Helical Coil Coarse Thread (Inch Series)

NASM124651 thru NASM124850

Insert, corrosion resistant Helical Coil Fine Thread (Inch Series)

NASM21209

Insert, Screw Thread, Self Locking (Inch Series)

NASM33537

Insert, Standard Dimensions, Assembly (Inch Series)

NASM8846

Insert, Screw Thread, Helical Coil (Inch Series)

MA1565

Insert, Screw Thread, Helical Coil (Metric Series)

MA1567

Insert, Screw Thread, Helical Coil, Standard Dimensions, Assembly (Metric Series)

MA3279, 3280, 3281

Insert, Screw Thread, Helical Coil, Free Running (Metric Series)

MA3329, 3330, 3331

Insert, Screw thread, Helical Coil, Screw-Locking (Metric Series)

AS59158

Tools for inserting and extracting Helical Coil Inserts

NAS1130

Inserts, Screw Thread, Helical Coil, Free Running and Screw-Locking (Inch Series)

NAS0276

Inserts, Screw Thread, Helical Coil, Free Running and Screw-Locking (Metric Series)

FED-STD-H28

Screw Thread Standards for Federal Services

AS3094A; AS3094 thru AS3097

AS1229B; AS3080 thru AS3083

Special Locking Torque Inserts

ASME B18.29.1

Insert, Screw Thread, Helical Coil (Inch Series)

ASME B18.29.2M-2005

Helical Coil Screw Thread Inserts, Free Running and Screw Locking (Metric Series)

AGS3600-3699

Insert, Screw Thread, Screw-Locking, Helical Coil, Cadmium Plated (Inch Series)

AGS4677 Series

Insert, Screw Thread, Screw-Locking, Helical Coil, Cadmium Plated (Metric Series)

AS6733

Inserts, Wire Thread, Unplated (UNF)

AS6734

Inserts, Wire Thread, Unplated (UNC)

AS8455

Inserts, Wire Thread, Cadmium Plated (UNF)

AS8456

Inserts, Wire Thread, Cadmium Plated (UNC)

Coatings/Plating

Benefits

Primer-Free® II



- » RoHS compliant; contains no chromates
- » Eliminates need for zinc primers and messy epoxies
- » Provides uniform top to bottom coverage
- » Provides enhanced visibility in the assembly
- » Prevents galvanic corrosion between insert and parent material
- » Eliminates locking torque issues associated with primers
- » Eliminates clogging/fouling of installation tools
- » Improves installation productivity
- » Provides additional lubrication facilitating insert installation

Material Spec: None

Color: Matte black

Dry Film Lubricant



- » Provides additional lubrication in high friction applications
- » High temperature resistance (400°F)
- » Highly recommended with Heli-Coil Screw-Locking inserts
- » Mildly corrosion resistant

Material Spec: AS5272

Color: Gray

Silver Plating



- » Recommended to reduce galling of threads at high temperatures
- » For use up to 1200°F
- » Highly recommended with inserts made from Inconel X-750

Material Spec: QQ-S-365

Color: Silver white

Cadmium Plating



- » For Military specification purposes only
- » Not recommended for new design due to its toxic nature

Material Spec: QQ-P-416 Type II

Color: Iridescent yellow - Free-Running

Color: Olive drab - Screw-Locking

Color Coding



- » Facilitates verification of insert installation
- » Allows for quick identification of similar size inserts

Color: Available in blue, green, red and black*

(*) Note: All Heli-Coil Inch Screw-Locking inserts are supplied with a red coloring in accordance with NASM21209.

Heli-Coil inserts are available in a wide choice of materials to suit specific application needs. Contact Heli-Coil Applications Engineering to determine the correct material for your application.



304 Stainless Steel

- » Standard, general purpose material
- » Ideal for original equipment applications, repair, and overhaul
- » Stocked in most sizes

Material Spec: AS7245

Temperature range: up to 800°F
 Tensile: 200,000 – 250,000 PSI
 Hardness: RHc 43-50
 Corrosion resistance: Moderate
 Magnetic Permeability: 2-10 G/o (depending on wire size)



Nitronic 60[®]

- » Superb gall resistance
- » Compatible with stainless steel screws
- » Ideal for use in vacuum environments
- » Requires no additional coatings or plating
- » Particle free
- » Non-magnetic

Material Spec: UNS S21800

Temperature range: up to 500°F
 Tensile: 200,000 PSI
 Hardness: RHc 43-50
 Corrosion resistance: Moderate
 Magnetic Permeability: <1 G/o



Inconel X-750

- » Used in areas exposed to high temperatures
- » Typical uses: gas turbine engines, nuclear applications, well drilling
- » Non-magnetic

Material Spec: AS7246

Temperature range: up to 1,000°F
 Tensile: 200,000 PSI
 Hardness: RHc 43-50
 Corrosion resistance: High
 Magnetic Permeability: <1 G/o



Phosphor Bronze

- » Ideal for salt water applications
- » Non-magnetic
- » Excellent electrical conductivity

Material Spec: ASTM B159-01 per UNS C51000 Grade A

Temperature range: up to 250°F
 Tensile: 140,000 PSI
 Hardness: HRB 95
 Corrosion resistance: High
 Magnetic Permeability: <1 G/o



Titanium

- » Superior strength-to-weight ratio
- » Corrosion resistant
- » Excellent low temperature stability

Material Spec: AMS 4957 & AMS 4958A

Temperature range: up to 600°F
 Tensile: 150,000 to 220,000 PSI
 Hardness: RHc 35-43
 Corrosion resistance: High
 Magnetic Permeability: Non-magnetic

Note: Nitronic 60[®] is a trademark of AK Steel

HeliCoil® Screw-Locking Torque Data

Heli-Coil Screw-Locking inserts meet the locking torque value of Tables I and II shown below. The values shown conform to NASM8846 (inch series) or MA1565 (metric series) requirement.

IMPORTANT NOTE: When using heat-treated steel screws or stainless steel screws with a Screw-Locking insert, an anti-seize compound MUST be applied to the screw or insert to minimize galling and maximize cycle life. Compounds include Primer Free® II coating or Dry Film Lubricant (Molybdenum Disulfide) to improve the wear life of the screws. In lieu of coatings, Heli-Coil Gall Resistant inserts are highly recommended.

TABLE I. HELI-COIL INSERT LOCKING TORQUE – INCH

Nominal Thread Size	Max. Locking Torque	Min. Locking Torque 15 th Cycle
UNIFIED COARSE THREAD (UNC)		
1 (.073)-64	15 oz-in	2 oz-in
2 (.086)-56	20 oz-in	3 oz-in
3 (.099)-48	32 oz-in	7 oz-in
4 (.112)-40	48 oz-in	10 oz-in
5 (.125)-40	75 oz-in	13 oz-in
6 (.138)-32	6 lb-in	1.0 lb-in
8 (.164)-32	9 lb-in	1.5 lb-in
10 (.190)-24	13 lb-in	2.0 lb-in
12 (.216)-24*	24 lb-in	3.0 lb-in
1/4 (.2500)-20	30 lb-in	4.5 lb-in
5/16 (.3125)-18	60 lb-in	7.5 lb-in
3/8 (.3750)-16	80 lb-in	12.0 lb-in
7/16 (.4375)-14	100 lb-in	16.5 lb-in
1/2 (.5000)-13	150 lb-in	24.0 lb-in
9/16 (.5625)-12	200 lb-in	30.0 lb-in
5/8 (.6250)-11	300 lb-in	40.0 lb-in
3/4 (.7500)-10	400 lb-in	60.0 lb-in
7/8 (.8750)-9	600 lb-in	82.0 lb-in
1 (1.000)-8	800 lb-in	110.0 lb-in
1-1/8 (1.1250)-7	900 lb-in	137.0 lb-in
1-1/4 (1.2500)-7	1000 lb-in	165.0 lb-in
1-3/8 (1.3750)-6	1150 lb-in	185.0 lb-in
1-1/2 (1.5000)-6	1350 lb-in	210.0 lb-in
UNIFIED FINE THREAD (UNF)		
2 (.086)-64	20 oz-in	3 oz-in
3 (.099)-56	32 oz-in	7 oz-in
4 (.112)-48	48 oz-in	10 oz-in
6 (.138)-40	6 lb-in	1.0 lb-in
8 (.164)-36	9 lb-in	1.5 lb-in
10 (.190)-32	13 lb-in	2.0 lb-in
1/4 (.2500)-28	30 lb-in	3.5 lb-in
5/16 (.3125)-24	60 lb-in	6.5 lb-in
3/8 (.3750)-24	80 lb-in	9.5 lb-in
7/16 (.4375)-20	100 lb-in	14.0 lb-in
1/2 (.5000)-20	150 lb-in	18.0 lb-in
9/16 (.5625)-18	200 lb-in	24.0 lb-in
5/8 (.6250)-18	300 lb-in	32.0 lb-in
3/4 (.7500)-16	400 lb-in	50.0 lb-in
7/8 (.8750)-14	600 lb-in	70.0 lb-in
1 (1.000)-14*	800 lb-in	92.0 lb-in
1 (1.000)-12	800 lb-in	90.0 lb-in
1-1/8 (1.1250)-12	900 lb-in	117.0 lb-in
1-1/4 (1.2500)-12	1000 lb-in	143.0 lb-in
1-3/8 (1.3750)-12	1150 lb-in	165.0 lb-in
1-1/2 (1.5000)-12	1350 lb-in	190.0 lb-in

TABLE II. HELI-COIL INSERT LOCKING TORQUE – METRIC

Nominal Thread Size	Max. Locking Torque	Min. Locking Torque 15 th Cycle (N.m)
METRIC COARSE		
M2x0.4	0.12	0.003
M2.2x0.45	0.14	0.02
M2.5x0.45	0.22	0.06
M3x0.5	0.44	0.10
M3.5x0.6	0.68	0.12
M4x0.7	0.90	0.16
M5x0.8	1.60	0.30
M6x1	3.00	0.40
M7x1	4.40	0.60
M8x1.25	6.00	0.80
M10x1.5	10.00	1.40
M12x1.75	15.00	2.20
M14x2	23.00	3.00
M16x2	32.00	4.20
M18x2.5	42.00	5.50
M20x2.5	54.00	7.00
M22x2.5	70.00	9.00
M24x3	80.00	11.00
M27x3	95.00	12.00
M30x3.5	110.00	14.00
M33x3.5	125.00	16.00
M36x4	140.00	18.00
M39x4	150.00	20.00
METRIC FINE		
M8x1	6.00	0.80
M10x1	10.00	1.40
M10x1.25	10.00	1.40
M12x1.25	15.00	2.20
M12x1.5	15.00	2.20
M14x1.5	23.00	3.00
M16x1.5	32.00	4.20
M18x1.5	42.00	5.50
M20x1.5	54.00	7.00
M22x1.5	70.00	9.00
M18x2	42.00	5.50
M20x2	54.00	7.00
M22x2	70.00	9.00
M24x2	80.00	11.00
M27x2	95.00	12.00
M30x2	110.00	14.00
M33x2	125.00	16.00
M36x2	140.00	18.00
M39x2	150.00	20.00
M36x3	140.00	18.00
M39x3	150.00	20.00

* These sizes are not included in NASM8846. Torque values shown are interpolated from sizes that are included. All torque data derived for stainless inserts only per NASM 8846 which applies to stainless steel, stainless with cadmium plating or with dry film lube.

Assembly Strength

Heli-Coil offers maximum design flexibility while adhering to conservative engineering practice allowing use of Heli-Coil inserts in virtually any application or material. Five lengths of inserts are available. In this design manual, the lengths are listed as multiples of the nominal thread diameter of the screw; 1, 1-1/2, 2, 2-1/2, and 3. This choice of insert length balances the bolt tensile strength against the shear strength of the parent material. This allows for the design of assemblies where the bolt will fail before the parent material. Tables III and IV below show the length of insert to be used with different combinations of bolts and parent materials.

Shear strength of parent material (PSI) (Alum., Mag., Steel)	54,000	75,000	96,000	108,000	125,000	132,000	160,000	180,000	220,000
10,000	2	2-1/2	3	3	–	–	–	–	–
15,000	1-1/2	1-1/2	2	2-1/2	2-1/2	3	3	–	–
20,000	1	1-1/2	1-1/2	2	2	2	2-1/2	3	3
25,000	1	1	1-1/2	1-1/2	1-1/2	2	2	2-1/2	2-1/2
30,000	1	1	1	1-1/2	1-1/2	1-1/2	2	2	2-1/2
40,000	1	1	1	1	1	1-1/2	1-1/2	1-1/2	2
50,000	1	1	1	1	1	1	1	1-1/2	1-1/2

Shear strength of parent material (MPa) (megapascals) (Alum., Mag., Steel)	300	400	500	600	800	1000	1200	1400
70	1.5	2	2.5	2.5	–	–	–	–
100	1	1.5	1.5	2	2.5	3	–	–
150	1	1	1.5	1.5	2	2	2.5	3
200	1	1	1	1	1.5	1.5	1.5	2.5
250	1	1	1	1	1	1.5	1.5	2
300	1	1	1	1	1	1.5	1.5	1.5
350	1	1	1	1	1	1	1.5	1.5

Guidelines for use of table:

1. When the parent material shear strength falls between two listed values, use the lower of the two values.
2. Parent material shear strengths are for room temperature. For applications at elevated temperatures, the shear strength of the material at that temperature must be determined for proper selection of bolt and insert length.
3. Be sure that the engaged thread length of the bolt is at least as long as the fully tapped thread depth for the size selected (Dimension "C", Tables VII & VIII, p. 20 -21).

Assembly strength is a function of shear area and the shear strength of both the bolt and parent material. For detailed charts on specific load values, Heli-Coil Technical Bulletin 68-2 (inch) or Engineering Standard PP15 (metric) covers the complete range of sizes, parent materials and bolt strengths.

Type of Conditions & Protective Methods

Parent Material	Parent Material Treatment			Insert Treatment		
	Normal	Severe	Extremely Severe	Normal	Severe	Extremely Severe
Aluminum	None	1	1	None	2 or 3	2 or 3
Magnesium	1	1	1	None	2 or 3	2 or 3

Corrosion Protection Methods

PARENT MATERIAL TREATMENT

Method 1

Aluminum: For oxide coating use Alodine, Anodize, Iridite, Hard Coat or equivalent. Iridite 14 or 14-2 (MIL-C-5541) is recommended for critical parts rather than anodizing (MIL-S-5002).

Magnesium: For oxide coating use Iridite 15 or dichromate surface treatments. For HAE finishes, always plug tapped holes first.

INSERT TREATMENT

Method 2 – Coat the insert with one of the following:

Dry Film Lubricant per AS5272 (MIL-L 46010) (no graphite) or when required by Mil Spec only, Cadmium per QQ-P-416, Type II, .0001" thick.

Method 3 – Utilize Heli-Coil Primer-Free II coated inserts. Alternatively, separate the parent material from the insert by using liquid zinc chromate primer, Federal Specification TT-P-1757. Apply the primer to the hole sparingly and install the insert while the primer is still wet.

In addition to the above methods, further corrosion protection can be achieved by:

- a. Using blind holes wherever possible.
- b. Using a sealing, insulating or step-down (5052 Alum.) washer under the head of the bolt.
- c. Using bolts that extend completely through the length of the insert.
- d. In critical applications, using a non-hardening sealer or compound on the threaded assembly.

Corrosion Protection

The effect of corrosion on threaded assemblies is dependent on many factors — environment, types of metals used, sealing mechanisms and length of service. The following recommendations apply for minimizing the effects of corrosion on Heli-Coil stainless steel insert assemblies at operating temperatures less than 800°F, using carbon steel or alloy steel bolts.

The following definitions apply...

Normal Service. Natural atmosphere environment with the screw always assembled in the insert.

Severe Service. Mildly contaminated atmospheric conditions involving moisture, occasional exposure to salty air or sea spray and the screw may be left out of the insert for extended periods of time.

Extremely Severe Service. Assembly is exposed to salt water, corrosive atmosphere and/or the screw is out of the assembly frequently allowing a blind hole to trap water.

HeliCoil® Tanged Insert Specifications – Inch

Nominal Thread Size	Type		Size Designation	"Q" Nominal Length					Outside Diameter		Number of Coils				
	Free Running Insert No.	Screw-Locking Insert No.		1 Dia.	1-1/2 Dia.	2 Dia.	2-1/2 Dia.	3 Dia.	Min.	Max.	1 Dia.	1-1/2 Dia.	2 Dia.	2-1/2 Dia.	3 Dia.
				UNIFIED COARSE THREAD (UNC)											
1 (.073)-64	1185	3585	01CN	0.073	0.110	0.146	0.182	0.219	.103	.103	2-3/4	4-7/8	6-7/8	8-7/8	10-7/8
2 (.086)-56	1185	3585	02CN	0.086	0.129	0.172	0.215	0.258	.110	.119	3	5-1/4	7-3/8	9-5/8	11-7/8
3 (.099)-48	1185	3585	03CN	0.099	0.148	0.198	0.248	0.297	.128	.139	2-7/8	5	7-1/4	9-3/8	11-1/2
4 (.112)-40	1185	3585	04CN	0.112	0.168	0.224	0.280	0.336	.144	.159	2-3/4	4-3/4	6-3/4	8-7/8	10-7/8
5 (.125)-40	1185	3585	05CN	0.125	0.188	0.250	0.312	0.375	.158	.173	3-1/4	5-1/2	7-3/4	10	12-1/4
6 (.138)-32	1185	3585	06CN	0.138	0.207	0.276	0.345	0.414	.178	.193	2-3/4	4-3/4	6-7/8	8-7/8	10-7/8
8 (.164)-32	1185	3585	2CN	0.164	0.246	0.328	0.410	0.492	.205	.220	3-1/2	6	8-3/8	10-3/4	13-1/4
10 (.190)-24	1185	3585	3CN	0.190	0.285	0.380	0.475	0.570	.244	.259	2-7/8	5	7-1/8	9-1/4	11-3/8
12 (.216)-24	1185	3585	1CN	0.216	0.324	0.432	0.540	0.648	.270	.285	3-1/2	6	8-3/8	10-5/8	13-1/8
1/4 (.2500)-20	1185	3585	4CN	0.250	0.375	0.500	0.625	0.750	.310	.330	3-3/8	5-3/4	8	10-3/8	12-3/4
5/16 (.3125)-18	1185	3585	5CN	0.312	0.469	0.625	0.781	0.938	.380	.400	4	6-5/8	9-1/4	11-7/8	14-5/8
3/8 (.3750)-16	1185	3585	6CN	0.375	0.562	0.750	0.938	1.125	.452	.472	4-3/8	7-1/4	10	12-7/8	15-3/4
7/16 (.4375)-14	1185	3585	7CN	0.438	0.656	0.875	1.094	1.312	.526	.551	4-1/2	7-3/8	10-1/4	13-1/8	16-1/8
1/2 (.5000)-13	1185	3585	8CN	0.500	0.750	1.000	1.250	1.500	.597	.622	4-7/8	7-7/8	11	14-1/8	17-1/8
9/16 (.5625)-12	1185	3585	9CN	0.562	0.844	1.125	1.406	1.688	.669	.694	5-1/8	8-1/4	11-1/2	14-3/4	17-7/8
5/8 (.6250)-11	1185	3585	10CN	0.625	0.938	1.250	1.562	1.875	.742	.767	5-1/4	8-1/2	11-3/4	15	18-3/8
3/4 (.7500)-10	1185	3585	12CN	0.750	1.125	1.500	1.875	2.250	.881	.906	5-7/8	9-3/8	13	16-1/2	20-1/8
7/8 (.8750)-9	1185	3585	14CN	0.875	1.312	1.750	2.188	2.625	1.022	1.052	6-1/4	10	13-3/4	17-1/2	21-1/4
1 (1.000)-8	1185	3585	16CN	1.000	1.500	2.000	2.500	3.000	1.166	1.196	6-3/8	10-1/8	14	17-3/4	21-5/8
1-1/8 (1.1250)-7	1185	3585	18CN	1.125	1.688	2.250	2.812	3.375	1.315	1.355	6-1/8	9-7/8	13-5/8	17-1/2	21-1/4
1-1/4 (1.2500)-7	1185	3585	20CN	1.250	1.875	2.500	3.125	3.750	1.443	1.483	7	11-1/4	15-3/8	19-1/2	23-3/4
1-3/8 (1.3750)-6	1185	3585	22CN	1.375	2.062	2.750	3.438	4.125	1.598	1.643	6-1/2	10-1/2	14-3/8	18-3/8	22-1/4
1-1/2 (1.5000)-6	1185	3585	24CN	1.500	2.250	3.000	3.750	4.500	1.727	1.772	7-1/4	11-1/2	15-7/8	20-1/8	24-1/2
UNIFIED FINE THREAD (UNF)															
2 (.086)-64	1191	3591	02CN	0.086	0.129	0.172	0.215	0.258	.110	.119	3-1/2	5-7/8	8-3/8	10-3/4	13-1/8
3 (.099)-56	1191	3591	03CN	0.099	0.148	0.198	0.248	0.297	.131	.146	3-3/8	5-5/8	8	10-3/8	12-5/8
4 (.112)-48	1191	3591	04CN	0.112	0.168	0.224	0.280	0.336	.147	.162	3-3/8	5-5/8	7-7/8	10-1/4	12-1/2
6 (.138)-40	1191	3591	06CN	0.138	0.207	0.276	0.345	0.414	.173	.193	3-1/2	6	8-3/8	10-3/4	13-1/4
8 (.164)-36	1191	3591	2CN	0.164	0.246	0.328	0.410	0.492	.204	.224	3-7/8	6-1/2	9-1/8	11-5/8	14-1/4
10 (.190)-32	1191	3591	3CN	0.190	0.285	0.380	0.475	0.570	.236	.256	4-1/8	6-7/8	9-1/2	12-1/4	14-7/8
1/4 (.2500)-28	1191	3591	4CN	0.250	0.375	0.500	0.625	0.750	.306	.326	5	8-1/4	11-3/8	14-1/2	17-5/8
5/16 (.3125)-24	1191	3591	5CN	0.312	0.469	0.625	0.781	0.938	.380	.400	5-1/2	8-7/8	12-1/4	15-5/8	19
3/8 (.3750)-24	1191	3591	6CN	0.375	0.562	0.750	0.938	1.125	.448	.468	6-7/8	11	15	19-1/8	23-1/8
7/16 (.4375)-20	1191	3591	7CN	0.438	0.656	0.875	1.094	1.312	.524	.549	6-5/8	10-5/8	14-5/8	18-1/2	22-1/2
1/2 (.5000)-20	1191	3591	8CN	0.500	0.750	1.000	1.250	1.500	.592	.617	7-7/8	12-3/8	16-7/8	21-3/8	25-7/8
9/16 (.5625)-18	1191	3591	9CN	0.562	0.844	1.125	1.406	1.688	.666	.691	8	12-1/2	17-1/8	21-3/4	26-1/4
5/8 (.6250)-18	1191	3591	10CN	0.625	0.938	1.250	1.562	1.875	.733	.758	9	14-1/8	19-1/4	24-1/4	29-3/8
3/4 (.7500)-16	1191	3591	12CN	0.750	1.125	1.500	1.875	2.250	.876	.901	9-3/4	15-1/8	20-5/8	26	31-1/2
7/8 (.8750)-14	1191	3591	14CN	0.875	1.312	1.750	2.188	2.625	1.021	1.051	9-7/8	15-1/2	21-1/8	26-5/8	32-1/4
1 (1.000)-14*	1191	3591	16CN	1.000	1.500	2.000	2.500	3.000	1.156	1.186	11-1/2	17-7/8	24-1/4	30-5/8	37
1 (1.000)-12	1191	3591	161CN	1.000	1.500	2.000	2.500	3.000	1.169	1.199	9-5/8	15	20-1/2	26	31-1/2
1-1/8 (1.1250)-12	1191	3591	18CN	1.125	1.688	2.250	2.812	3.375	1.304	1.334	11-1/8	17-1/4	23-3/8	29-1/2	35-3/4
1-1/4 (1.2500)-12	1191	3591	20CN	1.250	1.875	2.500	3.125	3.750	1.439	1.469	12-1/2	19-3/8	26-1/4	33	39-7/8
1-3/8 (1.3750)-12	1191	3591	22CN	1.375	2.062	2.750	3.438	4.125	1.575	1.610	13-3/4	21-3/8	28-7/8	36-1/2	44
1-1/2 (1.5000)-12	1191	3591	24CN	1.500	2.250	3.000	3.750	4.500	1.710	1.745	15-1/4	23-1/2	31-5/8	39-7/8	48-1/8

*Inactive for new design per NASM.

1185-4CNPF375S Complete Part No. Example: Free Running Insert; 1/4-20; Stainless Steel; Primer Free II; 1-1/2 dia.; On Strip

Type	Size	Material	Finish	Length	Packaging
1185 Free Running, Coarse	See Chart	CN – Stainless Steel	PF – Primer Free® II	See Chart	Blank – Bulk
1191 Free Running, Fine		BN – Phosphor Bronze	W – Dry Film Lubricant		S – Strip Feed
3585 Screw-Locking, Coarse		TN – Inconel X	Y – Cadmium		
3591 Screw-Locking, Fine		EN – Nitronic 60	V – Silver		
		GN – Titanium	Blank – None		

Notes on Insert Specifications:

- Nominal Length is a computed value and cannot be measured. It is the actual assembled length + 1/2 pitch.
- The number of coils are counted 90° from the tang.
- Grip Coil(s) Location for 1, 1-1/2 and 2 diameter long inserts, Grip Coil Location = 1/2 the number of free coils. For 2-1/2 and 3 diameter long inserts, Grip Coil Location (distance from the tang) is the same as 2 diameter long inserts.

Tanged Insert Specifications – Metric **Helicoil**[®]

Nominal Thread Size	Type		Size Designation	"Q" Nominal Length					Outside Diameter		Number of Coils				
	Free Running Insert No.	Screw-Locking Insert No.		1 Dia.	1-1/2 Dia.	2 Dia.	2-1/2 Dia.	3 Dia.	Min.	Max.	1 Dia.	1-1/2 Dia.	2 Dia.	2-1/2 Dia.	3 Dia.
				METRIC COARSE											
M2x0.4	1084	4184*	2CN	2.0	3.0	4.0	5.0	6.0	2.50	2.70	3-1/2	5-1/2	7-3/4	10-1/8	12-3/8
M2.2x0.45	1084	4184	2.2CN	2.2	3.3	4.4	5.5	6.6	2.80	3.00	3-1/8	5-3/8	7-5/8	9-7/8	12-1/8
M2.5x0.45	1084	4184	2.5CN	2.5	3.8	5.0	6.3	7.5	3.20	3.70	3-3/8	5-3/4	8-1/8	10-1/2	12-3/4
M3x0.5	1084	4184	3CN	3.0	4.5	6.0	7.5	9.0	3.80	4.35	3-3/4	6-3/8	8-7/8	11-3/8	13-7/8
M3.5x0.6	1084	4184	3.5CN	3.5	5.3	7.0	8.8	10.5	4.40	4.95	3-3/4	6-3/8	8-3/4	11-3/8	13-3/4
M4x0.7	1084	4184	4CN	4.0	6.0	8.0	10.0	12.0	5.05	5.60	3-5/8	6-1/8	8-5/8	11-1/8	13-5/8
M5x0.8	1084	4184	5CN	5.0	7.5	10.0	12.5	15.0	6.25	6.80	4-1/8	6-7/8	9-5/8	12-3/8	15-1/8
M6x1	1084	4184	6CN	6.0	9.0	12.0	15.0	18.0	7.40	7.95	4	6-3/4	9-1/2	12-1/8	14-7/8
M7x1	1084	4184	7CN	7.0	10.5	14.0	17.5	21.0	8.65	9.20	4-7/8	8	11-1/8	14-1/8	17-1/4
M8x1.25	1084	4184	8CN	8.0	12.0	16.0	20.0	24.0	9.80	10.35	4-1/2	7-3/8	10-1/4	13-1/4	16-1/8
M10x1.5	1084	4184	10CN	10.0	15.0	20.0	25.0	30.0	11.95	12.50	4-7/8	8	11-1/8	14-1/4	17-3/8
M12x1.75	1084	4184	12CN	12.0	18.0	24.0	30.0	36.0	14.30	15.00	5	8-1/4	11-1/2	14-5/8	17-7/8
M14x2	1084	4184	14CN	14.0	21.0	28.0	35.0	42.0	16.65	17.35	5-1/8	8-1/2	11-3/4	15	18-3/8
M16x2	1084	4184	16CN	16.0	24.0	32.0	40.0	48.0	18.90	19.60	6-1/8	9-3/4	13-1/2	17-1/4	21
M18x2.5	1084	4184	18CN	18.0	27.0	36.0	45.0	54.0	21.30	22.00	5-3/8	8-7/8	12-1/4	15-5/8	19
M20x2.5	1084	4184	20CN	20.0	30.0	40.0	50.0	60.0	23.55	24.40	6-1/8	9-7/8	13-5/8	17-3/8	21-1/8
M22x2.5	1084	4184	22CN	22.0	33.0	44.0	55.0	66.0	25.90	26.90	6-3/4	10-7/8	14-7/8	19	23-1/8
M24x3	1084	4184	24CN	24.0	36.0	48.0	60.0	72.0	28.00	29.00	6-1/8	10	13-3/4	17-1/2	21-3/8
M27x3	1084	4184	27CN	27.0	40.5	54.0	67.5	81.0	31.40	32.40	7	11-1/4	15-1/2	19-3/4	24
M30x3.5	1084	4184	30CN	30.0	45.0	60.0	75.0	90.0	34.80	36.00	6-3/4	10-3/4	14-7/8	18-7/8	23
M33x3.5	1084	4184	33CN	33.0	49.5	66.0	82.5	99.0	37.80	39.20	7-1/2	12	16-1/2	21	25-3/8
M36x4	1084	4184	36CN	36.0	54.0	72.0	90.0	108.0	41.50	42.90	7-1/8	11-3/8	15-5/8	19-7/8	24-1/4
M39x4	1084	4184	39CN	39.0	58.5	78.0	97.5	117.0	44.60	46.00	7-7/8	12-1/2	17-1/8	21-3/4	26-3/8

METRIC FINE

M8x1	4255	5255	8CN	8.0	12.0	16.0	20.0	24.0	9.70	10.25	5-7/8	9-3/8	13	16-1/2	20-1/8
M10x1	4255	5255	10CN	10.0	15.0	20.0	25.0	30.0	11.95	12.50	7-5/8	12	16-1/2	21	25-1/2
M10x1.25	4649	5649	10CN	10.0	15.0	20.0	25.0	30.0	12.10	12.65	5-7/8	9-1/2	13-1/8	16-3/4	20-3/8
M12x1.25	4649	5649	12CN	12.0	18.0	24.0	30.0	36.0	14.30	15.00	7-1/4	11-5/8	15-7/8	20-1/4	24-1/2
M12x1.5	3745	5145	12CN	12.0	18.0	24.0	30.0	36.0	14.25	14.95	6	9-5/8	13-3/8	17	20-3/4
M14x1.5	3745	5145	14CN	14.0	21.0	28.0	35.0	42.0	16.55	17.25	7-1/8	11-3/8	15-5/8	20	24-1/4
M16x1.5	3745	5145	16CN	16.0	24.0	32.0	40.0	48.0	18.90	19.60	8-1/4	13-1/8	18	22-3/4	27-5/8
M18x1.5	3745	5145	18CN	18.0	27.0	36.0	45.0	54.0	21.05	21.75	9-1/2	15	20-3/8	25-7/8	31-3/8
M20x1.5	3745	5145	20CN	20.0	30.0	40.0	50.0	60.0	23.15	24.00	10-3/4	16-7/8	22-7/8	28-7/8	35
M22x1.5	3745	5145	22CN	22.0	33.0	44.0	55.0	66.0	25.55	26.45	11-7/8	18-1/2	25-1/8	31-5/8	38-1/4
M18x2	4266	5266	18CN	18.0	27.0	36.0	45.0	54.0	21.15	21.85	7	11-1/8	15-3/8	19-1/2	23-5/8
M20x2	4266	5266	20CN	20.0	30.0	40.0	50.0	60.0	23.20	24.05	7-7/8	12-1/2	17-1/4	21-7/8	26-1/2
M22x2	4266	5266	22CN	22.0	33.0	44.0	55.0	66.0	25.60	26.50	8-3/4	13-3/4	18-7/8	23-7/8	29
M24x2	4266	5266	24CN	24.0	36.0	48.0	60.0	72.0	28.10	29.10	9-1/2	15	20-3/8	25-7/8	31-1/4
M27x2	4266	5266	27CN	27.0	40.5	54.0	67.5	81.0	31.30	32.30	10-7/8	17	23-1/4	29-3/8	35-1/2
M30x2	4266	5266	30CN	30.0	45.0	60.0	75.0	90.0	34.50	35.70	12-1/4	19-1/8	25-7/8	32-3/4	39-1/2
M33x2	4266	5266	33CN	33.0	49.5	66.0	82.5	99.0	37.80	39.20	13-5/8	21-1/8	28-5/8	36	43-1/2
M36x2	4266	5266	36CN	36.0	54.0	72.0	90.0	108.0	41.00	42.40	15	23-1/4	31-3/8	39-1/2	47-3/4
M39x2	4266	5266	39CN	39.0	58.5	78.0	97.5	117.0	44.30	45.70	16-3/8	25-1/4	34-1/8	43	51-7/8
M36x3	4277	5277	36CN	36.0	54.0	72.0	90.0	108.0	41.30	42.70	9-3/4	15-1/4	20-7/8	26-1/2	32
M39x3	4277	5277	39CN	39.0	58.5	78.0	97.5	117.0	44.40	45.80	10-3/4	16-3/4	22-3/4	28-7/8	34-7/8

*M2 not available in Screw-Locking 1 diameter length

1084-4CNPF040S

Complete Part No. Example: Free Running Insert; M4 x 0.7 Stainless Steel; Primer Free II; 1 dia.; On Strip

Type	Size	Material	Finish	Length	Packaging
1084 Free Running, Coarse	See Chart	CN – Stainless Steel	PF – Primer Free [®] II	See Chart	Blank – Bulk
4255, 4649, 3745, 4266 & 4277 Free Running, Fine		BN – Phosphor Bronze	W – Dry Film Lubricant		S – Strip Feed
4184 Screw-Locking, Coarse		TN – Inconel X	Y – Cadmium		
5255, 5649, 5145, 5266 & 5277 Screw-Locking, Fine		EN – Nitronic 60	V – Silver		
		GN – Titanium	Blank – None		

Notes on Insert Specifications:

- Nominal length is a computed value and cannot be measured. It is the actual assembled length + 1/2 pitch.
- The number of coils are counted from the notch.
- Phosphor Bronze Inserts – **Not available** in sizes M2, M2.2, M2.5, M3, M3.5 and M4.
- Inconel X Inserts – 1 diameter long Screw-Locking inserts **not available** in sizes M2, M2.2, M2.5 and M3

HeliCoil® Tangless® Insert Specifications – Inch

Tangless threaded inserts provide many advantages over Tanged inserts.

They eliminate the need for tang break off and tang retrieval and allow for non-destructive insert removal. Tangless inserts are easily adjusted and easily removed after installation.

Inch and metric size inserts are available in stainless steel and gall resistant (or Nitronic 60) materials. Finish options include Primer Free® II, Dry Film Lube (and Cadmium when required by Mil Spec.)



TANGLESS® INSERTS

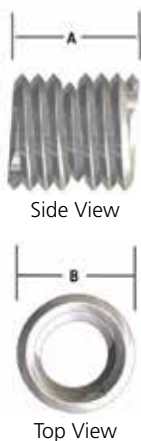

Nominal Thread Size	Type		Size Designation	A Length			B Free Outside Dia.		Number of Coils		
	Free Running	Screw-Locking		1 Dia.	1 1/2 Dia.	2 Dia.	Min.	Max.	1 Dia.	1 1/2 Dia.	2 Dia.
UNIFIED COARSE THREAD (UNC)											
2 (.086)-56	T1185	T3585	02C	.086	.129	.172	.110	.119	3	5-1/4	7-3/8
4 (.112)-40	T1185	T3585	04C	.112	.168	.224	.144	.159	2-3/4	4-3/4	6-3/4
6 (.138)-32	T1185	T3585	06C	.138	.207	.276	.178	.193	2-3/4	4-3/4	6-7/8
8 (.164)-32	T1185	T3585	2C	.164	.246	.328	.205	.220	3-1/2	6	8-3/8
10 (.190)-24	T1185	T3585	3C	.190	.285	.380	.244	.259	2-7/8	5	7-1/8
1/4(.250)-20	T1185	T3585	4C	.250	.375	.500	.310	.330	3-3/8	5-3/4	8
UNIFIED FINE THREAD (UNF)											
10(.190)-32	T1191	T3591	3C	.190	.285	.380	.236	.256	4-1/8	6-7/8	9-1/2
1/4(.250)-28	T1191	T3591	4C	.250	.375	.500	.306	.326	5	8-1/4	11-3/8

T3585-04CPF112S

Type	Size	Material	Finish	Length	Packaging
T1185 Free Running, UNC	See Chart	C - Stainless Steel	PF - Primer Free® II	See Chart	Blank - Bulk
T1191 Free Running, UNF		E - Nitronic 60	W - Dry Film Lube		S - Strip Feed
T3585 Screw-Locking, UNC			Y - Cadmium		
T3591 Screw-Locking, UNF			Blank - No Finish		

Complete Part No. Example: Screw-locking Insert; #4-40; Stainless Steel; Primer Free II, 1 dia.; On Strip

TANGLESS® STI TAPS AND GAGES

Nominal Thread Size	Straight Flute				Spiral Point Plug		High Spiral Flute		Working Gage	
	Plug		Bottoming		3B	2B	3B	2B	3B	2B
	3B	2B	3B	2B						
UNIFIED COARSE THREAD (UNC)										
2-56	02CPB	02CPA	02CBB	02CBA	02CSB	02CSA	5905-02	6905-02	3688-02	1442-02
4-40	04CPB	04CPA	04CBB	04CBA	04CSB	04CSA	5905-04	6905-04	3688-04	1442-04
6-32	06CPB	06CPA	06CBB	06CBA	06CSB	06CSA	5905-06	6905-06	3688-06	1442-06
8-32	2CPB	2CPA	2CBB	2CBA	2CSB	2CSA	5905-2	6905-2	3688-2	1442-2
10-24	3CPB	3CPA	3CBB	3CBA	3CSB	3CSA	5905-3	6905-3	3688-3	1442-3
1/4-20	4CPB	4CPA	4CBB	4CBA	4CSB	4CSA	5905-4	6905-4	3688-4	1442-4
UNIFIED FINE THREAD (UNF)										
10-32	3FPB	3FPA	3FBB	3FBA	3FSB	3FSA	5906-3	6906-3	3694-3	1443-3
1/4-28	4FPB	4FPA	4FBB	4FBA	4FSB	4FSA	5906-4	6906-4	3694-4	1443-4

FEATURES AND BENEFITS:

- » Stronger Assemblies.
 - Threads are stronger due to the flexibility of the insert providing a balanced distribution of the load
- » Cost Reduction.
 - Decreased installation and inspection time.
- » Bi-Directional Design
 - Installs quickly and easily from either end
- » FOD Design
 - No foreign object debris with no tang to remove; ideal for critical electronics applications

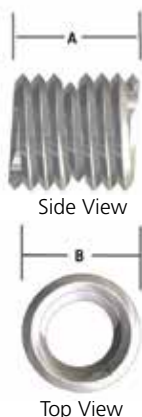

TANGLES[®] INSERTS

Nominal Thread Size	Type		Size Designation	A Length			B Free Outside Dia.		Number of Coils		
	Free Running	Screw-Locking		1 Dia.	1 1/2 Dia.	2 Dia.	Min.	Max.	1 Dia.	1 1/2 Dia.	2 Dia.
METRIC COARSE											
M2.5x0.45	T1084	T4184	2.5C	2.5	3.8	5.0	3.20	3.70	3-3/8	5-3/4	8-1/8
M3x0.5	T1084	T4184	3C	3.0	4.5	6.0	3.80	4.35	3-3/4	6-3/8	8-7/8
M4x0.7	T1084	T4184	4C	4.0	6.0	8.0	5.05	5.60	3-5/8	6-1/8	8-5/8
M5x0.8	T1084	T4184	5C	5.0	7.5	10.0	6.25	6.80	4-1/8	6-7/8	9-5/8
M6x1.0	T1084	T4184	6C	6.0	9.0	12.0	7.40	7.95	4	6-3/4	9-1/2

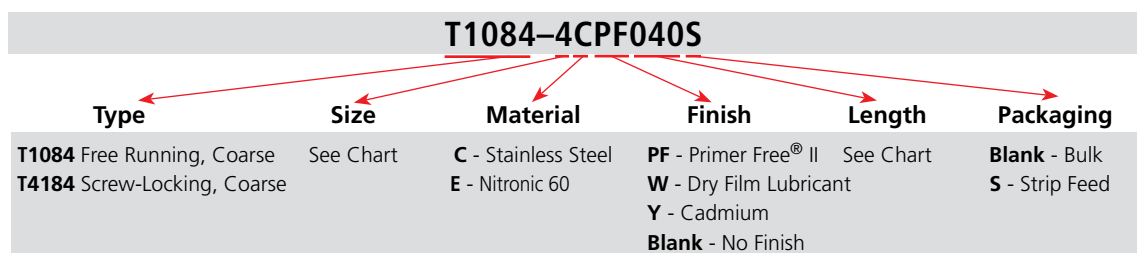

Complete Part No. Example: Free Running Insert; M4 x 0.7; Tap Stainless Steel; Primer Free II; 1 dia.; On Strip

TANGLES[®] STI TAPS AND GAGES

Nominal Thread Size	Straight Flute				Spiral Point Plug		High Spiral Flute		Reference Gage	
	Plug		Bottoming		Plug		Bottoming		Gage	
	4H5H	5H	4H5H	5H	4H5H	5H	4H5H	5H	4H	5H
METRIC COARSE										
M2.5x0.45	4687-2.5	2087-2.5	4693-2.5	2093-2.5	4863-2.5	4763-2.5	5081-2.5	4681-2.5	4624-2.5	1324-2.5
M3x0.5	4687-3	2087-3	4693-3	2093-3	4863-3	4763-3	5081-3	4681-3	4624-3	1324-3
M4x0.7	4687-4	2087-4	4693-4	2093-4	4863-4	4763-4	5081-4	4681-4	4624-4	1324-4
M5x0.8	4687-5	2087-5	4693-5	2093-5	4863-5	4763-5	5081-5	4681-5	4624-5	1324-5
M6x1.0	4687-6	2087-6	4693-6	2093-6	4863-6	4763-6	5081-6	4681-6	4624-6	1324-6

Boss Dimensions

Standard boss configurations may be used with Heli-Coil inserts.

A boss diameter of twice the nominal bolt size is adequate for most load conditions. For critical applications, the boss diameter should be twice the Heli-Coil tap major diameter (Tables VII & VIII, p. 20-21). Boss thickness is a function of the size and length of the insert chosen and the particular requirements of the component being designed. The use of Heli-Coil inserts generally minimizes the size of the boss because their high strength characteristics allow for smaller or fewer fasteners.

Class of Fit

Since Heli-Coil inserts are flexible, the class of fit of the final assembly is a function of the tapped hole. Heli-Coil STI (Screw Thread Insert) taps are available in inch series for both Class 2B and 3B. Metric Classes include 5H and 4H5H. Class 2B or 5H tapped holes provide widest production tolerances while Class 3B or 4H5H holes provide slightly tighter tolerances.

Class 3B or 4H5H holes are recommended for Screw-Locking applications.

Bolt Projection

Standard bolts and screws that need no special hardware are used with Heli-Coil inserts. The bolt must engage the entire insert to insure maximum assembly strength. It is strongly recommended that the tang always be removed and bolt projection be equal to the full tapped thread depth (**Dimension C**, Tables VII & VIII, p. 20-21). If design limitations prohibit this, contact us to obtain minimum bolt projection data.

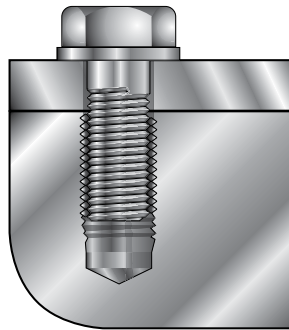

Torque Assembly Data

The torque to utilize for the mating fastener for Free Running inserts is per the bolt manufacturer's recommendation. The value for Screw-Locking inserts is also per the bolt manufacturer's recommendation, as well as the maximum locking torque. (See p.10)

Material Thickness

The **minimum** material thickness for through hole assemblies is equal to the Insert Nominal Length (**Dimension Q**, p.12-13), without a countersink and the insert installed 1/4-1/2 pitch below the surface. For production, the hole should be counter-sunk, and the insert installed 3/4-1-1/2 pitch below the surface. In this case the minimum material thickness is "Q" + 1 pitch.

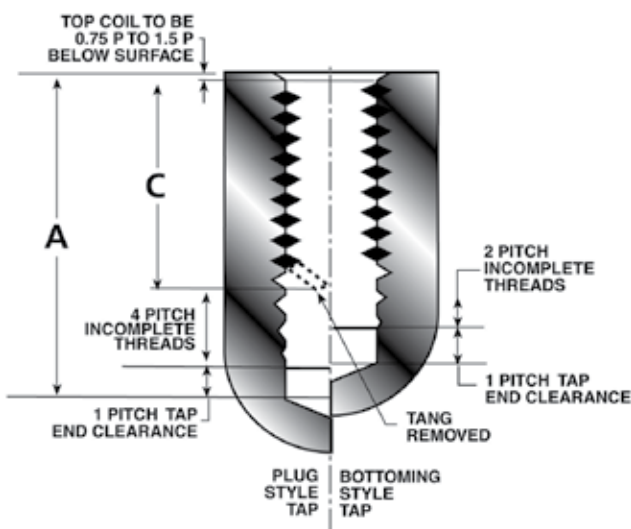
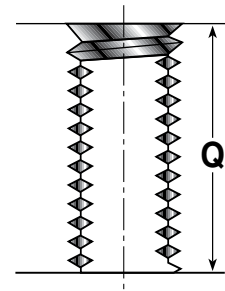

Hole Preparation

Drawing Call Out

On the left is a sectional view of an installed insert for a Heli-Coil Insert Assembly. The example used is a 3/8-24 x .562 long Screw-Locking insert in a blind hole, Class 3B fit, tapped with a plug tap.

Note: A is equivalent to the minimum drill depth; see Table V & VI on p. 18-19.

C is the minimum tapping depth; see Table VII & VIII on p. 20-21.

Engineering Data

Conventional machining methods are used for Heli-Coil assemblies.

The process is simple... **1. Drill 2. Countersink 3. Tap 4. Gage**

1. Drilling

The suggested drill sizes listed for aluminum in Tables V & VI, p. 18-19, are within the minor diameter limits specified in NASM33537 or MA1567. Drill sizes listed for steel, magnesium and plastic are larger (in most cases) allowing for parent material "close-in" in soft materials and increased tap wear life in hard materials.

The drill depths listed in this table allow for tap end clearance, maximum insert "set-down", countersink, and the chamfer on the tap. These drill depths are minimum and should be increased where possible, especially when using Spiral Pointed Taps, to allow for chip clearance. The formula for the drill depth is given on p.18-19.

2. Countersinking

Countersinking the drilled hole is recommended to prevent a feather edge at the top of the tapped hole and to help guide the insert into the tapped threads. A 120° included angle countersink is necessary to insure that the angle of the tapped thread and the countersink are the same ($120^\circ \div 2 = 60^\circ$ tapped thread).

3. Tapping

The dimensions for the depth of the full tapped thread (Dimension C, Tables VII & VIII, p.20-21) are MINIMUM for blind holes with countersinks. For through holes without a countersink the minimum full tapped thread depth must be equal to the insert nominal length (Dimension Q, p.12-13).

Heli-Coil taps for free machining materials are listed in Tables IX & XII, p.22 & 24 Class 2B (inch), 5H metric and 3B (inch) or 4H5H (metric) tapped holes. (Class of fit recommendations are given on p.14). There are four types of taps listed:

- a. Straight, Flute, Plug & Bottoming** style which are used for hand and short run production.
- b. Spiral Point Plug** taps (chips are pushed forward) are used for through holes and blind hole with ample chip clearance at the bottom.
- c. High Spiral Flute Bottoming** taps (chips are pulled out of the hole) are used for deep or blind holes in soft stringy materials and holes with minimal chip clearance.
- d. Roughing** taps (7/16-1") are available for materials difficult to tap to reduce the load and wear on the finishing tap.

If it is necessary to decrease the **Minimum Depth** of the drilled and tapped hole, one or more of the following steps may be helpful:

Action	Amount of Reduction
Remove the male center on plug taps 5/16, M8 & under	one half of the bolt diameter
Use a bottoming tap	2 pitches
Eliminate the countersink	1/2 pitch
Reduce insert "set-down" to 1/4-1/2 pitch	up to 1/2 pitch

4. Gaging

Heli-Coil thread plug gages should be used to check the tapped holes before insert installation and according to sampling plan. See p.26-27 for gage part numbers and further gaging data.

Preparing Process Sheets

A sample process sheet for preparing a tapped hole for Heli-Coil inserts is shown below. Highlighted are references to the various dimensional data and part number specifications listed in the tables on pages listed. Insert installation and tang break off are covered in subsequent pages.

Hole preparation for 3/8-24, Screw-Locking Heli-Coil Insert, .562 long, Part No. 3591-6CN562 Blind Hole, Class 3B, tapped with a plug tap in aluminum

Sequence	Operation Description	Tool or Gage
1	Drill hole .3840/.3910 diameter to minimum depth (Dimension A, Tables V & VI, p. 18-19)	25/64 drill (.3906), Tables V & VI, p. 17-19
2	Countersink 120°±5° to .42/.45 diameter (Dimension M, Tables VII & VIII, p. 20-21)	120° countersink
3	Tap 3/8 (.3750)-24 UNF-3B STI Thread Depth .600 (Dimension C, Tables VII & VIII, p. 20-21)	Heli-Coil tap 6FPB, Tables IX & XI, p. 22 & 24
4	Remove chips	Air Nozzle
5	Gage according to your sampling plan	Heli-Coil gage 3694-6, p. 26-27
6	Install 3591-6CN562 Heli-Coil insert 3/4 to 1-1/2 pitch below surface	Installation Tool 7552-6, p. 29
7	Break off tang	Heli-Coil tang break-off tool 3692-6, p. 33

The **minimum** drilling depths shown below allow for the following recommended practices:

1. Countersinking the drilled hole to prevent a feather edge at the start of the tapped hole.
2. 3/4 – 1-1/2 pitch of insert **“set-down”** to allow for maximum production tolerance. Dimensions are shown for both plug and bottoming taps.

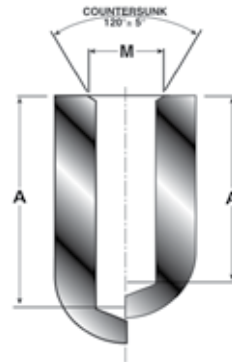

TABLE V – INCH DRILLED HOLE DIMENSIONS

Nominal Thread Size	Suggested Drill Size		"A" MINIMUM DRILLING DEPTH FOR EACH INSERT LENGTH									
	Aluminum	Steel, Magnesium, Plastic	Plug Taps					Bottoming Taps				
			1 Dia.	1-1/2 Dia.	2 Dia.	2-1/2 Dia.	3 Dia.	1 Dia.	1-1/2 Dia.	2 Dia.	2-1/2 Dia.	3 Dia.
UNIFIED COARSE THREAD (UNC)												
1 (.073)-64	#47 (.0785)	#46 (.0810)	.203	.240	.276	.313	.349	.136	.172	.209	.245	.282
2 (.086)-56	3/32 (.0938)	#41 (.0960)	.236	.279	.322	.365	.408	.157	.200	.243	.286	.329
3 (.099)-48	#36 (.1065)	7/64 (.1094)	.273	.323	.372	.422	.471	.182	.232	.281	.331	.380
4 (.112)-40	#31 (.1200)	#31 (.1200)	.318	.374	.430	.486	.542	.212	.268	.324	.380	.436
5 (.125)-40	3.4mm (.1339)	#29 (.1360)	.338	.400	.462	.525	.588	.225	.288	.350	.412	.475
6 (.138)-32	#26 (.1470)	#25 (.1495)	.394	.464	.532	.602	.670	.263	.332	.401	.470	.539
8 (.164)-32	#17 (.1730)	#16 (.1770)	.434	.516	.598	.680	.762	.289	.371	.453	.535	.617
10 (.190)-24	13/64 (.2031)	#5 (.2055)	.535	.630	.725	.820	.915	.357	.452	.547	.642	.737
12 (.216)-24*	#1 (.2280)	#1 (.2280)	.574	.682	.790	.898	1.006	.383	.491	.599	.707	.815
1/4 (.2500)-20	H (.2660)	H (.2660)	.675	.800	.925	1.050	1.175	.450	.575	.700	.825	.950
5/16 (.3125)-18	Q (.3320)	Q (.3320)	.801	.957	1.113	1.269	1.425	.534	.690	.846	1.002	1.158
3/8 (.3750)-16	X (.3970)	X (.3970)	.750	.938	1.125	1.312	1.500	.625	.812	1.000	1.188	1.375
7/16 (.4375)-14	29/64 (.4531)	29/64 (.4531)	.867	1.086	1.305	1.524	1.743	.724	.943	1.162	1.381	1.600
1/2 (.5000)-13*	33/64 (.5156)	17/32 (.5312)	.962	1.212	1.462	1.712	1.962	.808	1.058	1.308	1.558	1.808
9/16 (.5625)-12*	37/64 (.5781)	19/32 (.5938)	1.062	1.343	1.624	1.905	2.186	.895	1.176	1.457	1.738	2.019
5/8 (.6250)-11	21/32 (.6562)	21/32 (.6562)	1.170	1.483	1.795	2.108	2.420	.989	1.301	1.614	1.926	2.239
3/4 (.7500)-10	25/32 (.7812)	25/32 (.7812)	1.350	1.725	2.100	2.475	2.850	1.150	1.525	1.900	2.275	2.650
7/8 (.8750)-9	29/32 (.9062)	29/32 (.9062)	1.542	1.979	2.417	2.854	3.292	1.319	1.757	2.194	2.632	3.069
1 (1.000)-8	1-1/32 (1.0312)	1-1/32 (1.0312)	1.750	2.250	2.750	3.250	3.750	1.500	2.000	2.500	3.000	3.500
1-1/8 (1.1250)-7	1-11/64 (1.1719)	1-11/64 (1.1719)	1.982	2.545	3.107	3.670	4.232	1.696	2.259	2.821	3.384	3.946
1-1/4 (1.2500)-7	1-19/64 (1.2969)	1-19/64 (1.2969)	2.107	2.732	3.357	3.982	4.607	1.821	2.446	3.071	3.696	4.321
1-3/8 (1.3750)-6	1-27/64 (1.4219)	1-27/64 (1.4219)	2.375	3.062	3.750	4.437	5.125	2.042	2.729	3.417	4.104	4.792
1-1/2 (1.5000)-6	1-35/64 (1.5469)	1-35/64 (1.5469)	2.500	3.250	4.000	4.750	5.500	2.167	2.917	3.667	4.417	5.167
UNIFIED FINE THREAD (UNF)												
2 (.086)-64	2.35mm (.0925)	2.35mm (.0925)	.223	.266	.309	.352	.395	.149	.192	.235	.278	.321
3 (.099)-56	#37 (.1040)	#36 (.1065)	.256	.305	.355	.404	.454	.170	.220	.269	.319	.368
4 (.112)-48	3mm (.1181)	#31 (.1200)	.293	.349	.405	.461	.517	.195	.251	.307	.363	.419
6 (.138)-40	#26 (.1470)	#25 (.1495)	.357	.426	.495	.564	.633	.238	.307	.376	.445	.514
8 (.164)-36	#17 (.1730)	#16 (.1770)	.413	.495	.577	.659	.741	.275	.357	.439	.521	.603
10 (.190)-32	#7 (.2010)	13/64 (.2031)	.472	.568	.662	.758	.852	.315	.410	.505	.600	.695
1/4 (.2500)-28	G (.2610)	6.7mm (.2638)	.589	.714	.839	.964	1.089	.393	.518	.643	.768	.893
5/16 (.3125)-24	21/64 (.3281)	21/64 (.3281)	.718	.874	1.030	1.186	1.342	.479	.635	.791	.947	1.103
3/8 (.3750)-24	25/64 (.3906)	25/64 (.3906)	.625	.812	1.000	1.187	1.375	.542	.729	.917	1.104	1.292
7/16 (.4375)-20	29/64 (.4531)	29/64 (.4531)	.738	.957	1.176	1.395	1.614	.638	.857	1.076	1.295	1.514
1/2 (.5000)-20	33/64 (.5156)	33/64 (.5156)	.800	1.050	1.300	1.550	1.800	.700	.950	1.200	1.450	1.700
9/16 (.5625)-18	37/64 (.5781)	37/64 (.5781)	.895	1.176	1.457	1.738	2.019	.784	1.065	1.346	1.627	1.908
5/8 (.6250)-18	41/64 (.6406)	41/64 (.6406)	.958	1.271	1.583	1.896	2.208	.847	1.160	1.472	1.785	2.097
3/4 (.7500)-16	49/64 (.7656)	49/64 (.7656)	1.125	1.500	1.875	2.250	2.625	1.000	1.375	1.750	2.125	2.500
7/8 (.8750)-14	57/64 (.8906)	57/64 (.8906)	1.304	1.741	2.179	2.616	3.054	1.161	1.598	2.036	2.473	2.911
1 (1.000)-14	1-1/64 (1.0156)	1-1/32 (1.0312)	1.429	1.929	2.429	2.929	3.429	1.286	1.786	2.286	2.786	3.286
1 (1.000)-12*	1-1/64 (1.0156)	1-1/32 (1.0312)	1.500	2.000	2.500	3.000	3.500	1.333	1.833	2.333	2.833	3.333
1-1/8 (1.1250)-12*	1-9/64 (1.1406)	1-5/32 (1.1562)	1.625	2.187	2.750	3.312	3.875	1.458	2.021	2.583	3.146	3.708
1-1/4 (1.2500)-12*	1-17/64 (1.2656)	1-9/32 (1.2812)	1.750	2.375	3.000	3.625	4.250	1.583	2.208	2.833	3.458	4.083
1-3/8 (1.3750)-12*	1-25/64 (1.3906)	1-13/32 (1.4062)	1.875	2.562	3.250	3.937	4.625	1.708	2.396	3.083	3.771	4.458
1-1/2 (1.5000)-12*	1-33/64 (1.5156)	1-17/32 (1.5312)	2.000	2.750	3.500	4.250	5.000	1.833	2.583	3.333	4.083	4.833

*Standard size drills are suggested even though in these sizes they vary slightly from minor diameter specifications in NASM33537.

For Plug Taps 5/16" or M8 and smaller.

A is equal to the insert nominal length (Q) + ½ the nominal bolt diameter + 5 Pitch (allowing for tap chamfer, countersink and maximum "set-down").

For Plug Taps 3/8" or M10 and larger.

A is equal to the insert nominal length (Q) + 5 Pitch (allowing for tap chamfer, counter sink and maximum "set-down").

For Bottoming Taps.

A is equal to the insert nominal length (Q) + 3 Pitch (allowing for tap chamfer, countersink and maximum "set-down").

Note: Plug taps 5/16" or M8 and smaller have a male center and the drilled hole depth dimensions allow for this length (one half of the diameter of the bolt).

Calculation of dimension "A" is described to the left and on p. 18.

Note: "Q" dimensions are on p.12-13.

TABLE VI – METRIC DRILLED HOLE DIMENSIONS

Nominal Thread Size	Suggested Drill Size		"A" MINIMUM DRILLING DEPTH FOR EACH INSERT LENGTH									
	Aluminum	Steel, Magnesium, Plastic	Plug Taps					Bottoming Taps				
			1 Dia.	1-1/2 Dia.	2 Dia.	2-1/2 Dia.	3 Dia.	1 Dia.	1-1/2 Dia.	2 Dia.	2-1/2 Dia.	3 Dia.
METRIC COARSE												
M2X0.4	2.10	2.10	5.40	6.40	7.40	8.40	9.40	3.60	4.60	5.60	6.60	7.60
M2.2x0.45	2.30	2.35	6.00	7.10	8.20	9.30	10.40	4.00	5.10	6.20	7.30	8.40
M2.5x0.45	2.55	2.65	6.45	7.70	8.95	10.20	11.45	4.30	5.55	6.80	8.05	9.30
M3x0.5	3.15	3.20	7.50	9.00	10.50	12.00	13.50	5.00	6.50	8.00	9.50	11.00
M3.5x0.6	3.70	3.70	8.85	10.60	12.35	14.10	15.85	5.90	7.65	9.40	11.15	12.90
M4x0.7	4.20	4.25	10.20	12.20	14.20	16.20	18.20	6.80	8.80	10.80	12.80	14.80
M5x0.8	5.20	5.30	12.30	14.80	17.30	19.80	22.30	8.20	10.70	13.20	15.70	18.20
M6x1	6.25	6.30	15.00	18.00	21.00	24.00	27.00	10.00	13.00	16.00	19.00	22.00
M7x1	7.25	7.30	16.50	20.00	23.50	27.00	30.50	11.00	14.50	18.00	21.50	25.00
M8x1.25	8.30	8.40	19.50	23.50	27.50	31.50	35.50	13.00	17.00	21.00	25.00	29.00
M10x1.5	10.50	10.50	19.00	24.00	29.00	34.00	39.00	16.00	21.00	26.00	31.00	36.00
M12x1.75	12.50	12.50	22.50	28.50	34.50	40.50	46.50	19.00	25.00	31.00	37.00	43.00
M14x2	14.50	14.50	26.00	33.00	40.00	47.00	54.00	22.00	29.00	36.00	43.00	50.00
M16x2	16.50	16.50	28.00	36.00	44.00	52.00	60.00	24.00	32.00	40.00	48.00	56.00
M18x2.5	18.75	18.75	33.00	42.00	51.00	60.00	69.00	28.00	37.00	46.00	55.00	64.00
M20x2.5	20.75	20.75	35.00	45.00	55.00	65.00	75.00	30.00	40.00	50.00	60.00	70.00
M22x2.5	22.75	22.75	37.00	48.00	59.00	70.00	81.00	32.00	43.00	54.00	65.00	76.00
M24x3	24.75	24.75	42.00	54.00	66.00	78.00	90.00	36.00	48.00	60.00	72.00	84.00
M27x3	27.75	27.75	45.00	58.50	72.00	85.50	99.00	39.00	52.50	66.00	79.50	93.00
M30x3.5	31.00	31.00	51.00	66.00	81.00	96.00	111.00	44.00	59.00	74.00	89.00	104.00
M33x3.5	34.00	34.00	54.00	70.50	87.00	103.50	120.00	47.00	63.50	80.00	96.50	113.00
M36x4	37.00	37.00	60.00	78.00	96.00	114.00	132.00	52.00	70.00	88.00	106.00	124.00
M39x4	40.00	40.00	63.00	82.50	102.00	121.50	141.00	55.00	74.50	94.00	113.50	133.00
METRIC FINE												
M8x1	8.25	8.30	18.00	22.00	26.00	30.00	34.00	12.00	16.00	20.00	24.00	28.00
M10x1	10.25	10.25	16.00	21.00	26.00	31.00	36.00	14.00	19.00	24.00	29.00	34.00
M10x1.25*	10.25	10.25	17.50	22.50	27.50	32.50	37.50	15.00	20.00	25.00	30.00	35.00
M12x1.25*	12.25	12.25	19.50	25.50	31.50	37.50	43.50	17.00	23.00	29.00	35.00	41.00
M12x1.5*	12.25	12.50	21.00	27.00	33.00	39.00	45.00	18.00	24.00	30.00	36.00	42.00
M14x1.5*	14.25	14.50	23.00	30.00	37.00	44.00	51.00	20.00	27.00	34.00	41.00	48.00
M16x1.5*	16.25	16.50	25.00	33.00	41.00	49.00	57.00	22.00	30.00	38.00	46.00	54.00
M18x1.5*	18.25	18.50	27.00	36.00	45.00	54.00	63.00	24.00	33.00	42.00	51.00	60.00
M20x1.5*	20.25	20.50	29.00	39.00	49.00	59.00	69.00	26.00	36.00	46.00	56.00	66.00
M22x1.5*	22.25	22.50	31.00	42.00	53.00	64.00	75.00	28.00	39.00	50.00	61.00	72.00
M18x2	18.50	18.50	30.00	39.00	48.00	57.00	66.00	26.00	35.00	44.00	53.00	62.00
M20x2	20.50	20.50	32.00	42.00	52.00	62.00	72.00	28.00	38.00	48.00	58.00	68.00
M22x2	22.50	22.50	34.00	45.00	56.00	67.00	78.00	30.00	41.00	52.00	63.00	74.00
M24x2	24.50	24.50	36.00	48.00	60.00	72.00	84.00	32.00	44.00	56.00	68.00	80.00
M27x2	27.50	27.50	39.00	52.50	66.00	79.50	93.00	35.00	48.50	62.00	75.50	89.00
M30x2	30.50	30.50	42.00	57.00	72.00	87.00	102.00	38.00	53.00	68.00	83.00	98.00
M33x2	33.50	33.50	45.00	61.50	78.00	94.50	111.00	41.00	57.50	74.00	90.50	107.00
M36x2	36.50	36.50	48.00	66.00	84.00	102.00	120.00	44.00	62.00	80.00	98.00	116.00
M39x2	39.50	39.50	51.00	70.50	90.00	109.00	129.00	47.00	66.50	86.00	105.50	125.00
M36x3	37.00	37.00	54.00	72.00	90.00	108.00	126.00	48.00	66.00	84.00	102.00	120.00
M39x3	40.00	40.00	57.00	76.50	96.00	115.50	135.00	51.00	70.50	90.00	109.50	129.00

* Standard size drills are suggested even though in these sizes they vary slightly from minor diameter limits.

HeliCoil® Tapping Data – Inch

The **minimum** tapping depths shown below (Dimension **C**) are the minimum for countersunk holes and an insert set-down of 1 – 1/2 pitch maximum. The calculation for Dimension “C” is:

C is equal to insert nominal length + 1 Pitch.

The tapped hole must be held within the stated pitch diameter limits for the required class of fit for the installed Heli-Coil insert.

When anodize, Iridite or other finishes are used, all tapped hole dimensions must be met after the finishes are applied.

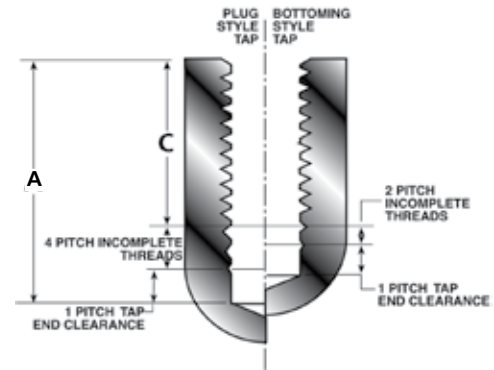

TABLE VII – INCH TAPPED HOLE DIMENSIONS

Nominal Thread Size	Countersink "M" Diameter (120° ±5° included angle)		Pitch Diameter			"C" MINIMUM TAPPING DEPTH					Minor Diameter (after tapping)		Tap Major Dia. Max.	Thread Pitch	
	Min.	Max.	Min.	3B Max.	2B Max.	INSERT LENGTH					Min.	Max.			
						1 Dia.	1-1/2 Dia.	2 Dia.	2-1/2 Dia.	3 Dia.					
UNIFIED COARSE THREAD (UNC)															
1 (.073)-64	.085	.10	.0832	.0843	.0850	.090	.125	.160	.200	.235	.0764	.0823	.0958	.01563	
2 (.086)-56	.09	.11	.0976	.0989	.0996	.100	.150	.190	.230	.280	.0899	.0961	.1117	.01786	
3 (.099)-48	.11	.14	.1126	.1140	.1148	.120	.170	.220	.270	.320	.1036	.1104	.1289	.02083	
4 (.112)-40	.14	.17	.1283	.1299	.1308	.140	.190	.250	.310	.360	.1175	.1252	.1473	.02500	
5 (.125)-40	.16	.19	.1413	.1430	.1438	.150	.210	.280	.340	.400	.1305	.1373	.1603	.02500	
6 (.138)-32	.18	.21	.1583	.1601	.1611	.170	.240	.310	.380	.450	.1448	.1527	.1817	.03125	
8 (.164)-32	.20	.23	.1843	.1862	.1872	.200	.280	.360	.440	.520	.1708	.1781	.2077	.03125	
10 (.190)-24	.24	.27	.2170	.2192	.2203	.230	.330	.420	.520	.610	.1990	.2080	.2475	.04167	
12 (.216)-24	.26	.29	.2430	.2453	.2464	.260	.370	.470	.580	.690	.2250	.2340	.2735	.04167	
1/4 (.2500)-20	.31	.34	.2825	.2851	.2864	.300	.430	.550	.680	.800	.2608	.2704	.3187	.05000	
5/16 (.3125)-18	.38	.41	.3486	.3515	.3529	.370	.530	.680	.840	.990	.3245	.3342	.3884	.05556	
3/8 (.3750)-16	.45	.48	.4156	.4189	.4203	.440	.630	.810	1.000	1.190	.3885	.3987	.4602	.06250	
7/16 (.4375)-14	.52	.55	.4839	.4875	.4890	.510	.730	.950	1.170	1.380	.4530	.4639	.5343	.07143	
1/2 (.5000)-13	.59	.62	.5499	.5537	.5554	.580	.830	1.080	1.330	1.580	.5166	.5273	.6042	.07692	
9/16 (.5625)-12	.66	.69	.6167	.6208	.6225	.650	.930	1.210	1.490	1.770	.5806	.5918	.6751	.08333	
5/8 (.6250)-11	.73	.76	.6841	.6885	.6903	.720	1.030	1.340	1.650	1.970	.6447	.6564	.7477	.09091	
3/4 (.7500)-10	.87	.90	.8149	.8196	.8216	.850	1.230	1.600	1.980	2.350	.7716	.7838	.8850	.10000	
7/8 (.8750)-9	1.00	1.03	.9471	.9522	.9543	.990	1.420	1.860	2.300	2.740	.8990	.9119	1.0247	.11111	
1 (1.000)-8	1.14	1.17	1.0812	1.0868	1.0890	1.130	1.630	2.130	2.630	3.130	1.0271	1.0421	1.1681	.12500	
1-1/8 (1.1250)-7	1.29	1.32	1.2178	1.2239	1.2262	1.270	1.830	2.390	2.960	3.520	1.1559	1.1730	1.3171	.14286	
1-1/4 (1.2500)-7	1.41	1.44	1.3428	1.3490	1.3514	1.390	2.020	2.640	3.270	3.890	1.2809	1.2980	1.4421	.14286	
1-3/8 (1.3750)-6	1.56	1.59	1.4832	1.4900	1.4926	1.540	2.230	2.920	3.600	4.290	1.4110	1.4310	1.5982	.16667	
1-1/2 (1.5000)-6	1.69	1.72	1.6082	1.6151	1.6177	1.670	2.420	3.170	3.920	4.670	1.5360	1.5560	1.7232	.16667	
UNIFIED FINE THREAD (UNF)															
2 (.086)-64	.09	.11	.0962	.0974	.0981	.100	.145	.190	.230	.275	.0894	.0947	.1088	.01563	
3 (.099)-56	.11	.14	.1106	.1119	.1126	.120	.170	.220	.270	.310	.1029	.1086	.1247	.01786	
4 (.112)-48	.14	.17	.1256	.1271	.1279	.130	.190	.240	.300	.360	.1166	.1229	.1419	.02083	
6 (.138)-40	.17	.20	.1543	.1560	.1569	.160	.230	.300	.370	.440	.1435	.1503	.1733	.02500	
8 (.164)-36	.20	.23	.1821	.1840	.1849	.190	.270	.360	.440	.520	.1701	.1771	.2032	.02778	
10 (.190)-32	.23	.26	.2103	.2123	.2133	.220	.320	.410	.510	.600	.1968	.2041	.2337	.03125	
1/4 (.2500)-28	.29	.32	.2732	.2754	.2765	.290	.410	.540	.660	.790	.2577	.2646	.2995	.03571	
5/16 (.3125)-24	.36	.39	.3395	.3421	.3433	.350	.510	.670	.820	.980	.3215	.3288	.3700	.04167	
3/8 (.3750)-24	.42	.45	.4020	.4047	.4059	.420	.600	.790	.980	1.170	.3840	.3910	.4325	.04167	
7/16 (.4375)-20	.50	.53	.4700	.4731	.4744	.490	.710	.930	1.140	1.360	.4483	.4561	.5062	.05000	
1/2 (.5000)-20	.56	.59	.5325	.5357	.5371	.550	.800	1.050	1.300	1.550	.5108	.5186	.5687	.05000	
9/16 (.5625)-18	.63	.66	.5986	.6020	.6035	.620	.900	1.180	1.460	1.740	.5745	.5826	.6384	.05556	
5/8 (.6250)-18	.69	.72	.6611	.6646	.6661	.680	.990	1.310	1.620	1.930	.6370	.6451	.7009	.05556	
3/4 (.7500)-16	.82	.85	.7906	.7945	.7961	.810	1.190	1.560	.1940	2.310	.7635	.7720	.8352	.06250	
7/8 (.8750)-14	.96	.99	.9214	.9257	.9274	.950	1.380	1.820	2.260	2.700	.8905	.8994	.9718	.07143	
1 (1.000)-14	1.08	1.11	1.0464	1.0508	1.0527	1.070	1.570	2.070	2.570	3.070	1.0155	1.0243	1.0968	.07143	
1 (1.000)-12	1.10	1.13	1.0542	1.0589	1.0608	1.080	1.580	2.080	2.580	3.080	1.0181	1.0281	1.1126	.08333	
1-1/8 (1.1250)-12	1.22	1.25	1.1792	1.1841	1.1860	1.210	1.770	2.330	2.900	3.460	1.1431	1.1531	1.2376	.08333	
1-1/4 (1.2500)-12	1.35	1.38	1.3042	1.3092	1.3112	1.330	1.960	2.580	3.210	3.830	1.2681	1.2781	1.3626	.08333	
1-3/8 (1.3750)-12	1.47	1.50	1.4292	1.4343	1.4364	1.460	2.150	2.830	3.520	4.210	1.3931	1.4031	1.4876	.08333	
1-1/2 (1.5000)-12	1.60	1.63	1.5542	1.5595	1.5615	1.580	2.330	3.080	3.830	4.580	1.5181	1.5281	1.6126	.08333	

Heli-Coil taps in various types and styles produce holes for Tolerance Classes 4H5H or 3B and 5H or 2B for use in the general range of aluminums, magnesiums, mild steels, free machining stainless steels and other free machining materials.

The tapped hole must be held within the stated pitch diameter limits for the required Tolerance Class of fit for the installed Heli-Coil insert. For Standard (free running inserts), a tolerance class 5H or 2B is recommended. For Screw-Locking inserts, a tolerance class 4H5H or 3B is recommended in order to develop higher locking torques.

Conventional shop practice and production procedures, speeds, feeds and lubricants should be used in combination with proper fixturing and good tapping machines or tapping heads.

TABLE VIII – METRIC TAPPED HOLE DIMENSIONS

Nominal Thread Size	Countersink "M" Diameter (120° ±5° included angle)		Pitch Diameter			"C" MINIMUM TAPPING DEPTH					Minor Diameter (after tapping)		Tap Major Dia. Max.
	Min.	Max.	Min.	4H5H Max.	5H Max.	INSERT LENGTH					Min.	Max.	
						1 Dia.	1-1/2 Dia.	2 Dia.	2-1/2 Dia.	3 Dia.			
METRIC COARSE													
M2X0.4	2.30	2.70	2.260	2.295	2.310	2.4	3.4	4.4	5.4	6.4	2.087	2.199	2.581
M2.2x0.45	2.40	2.90	2.492	2.532	2.547	2.7	3.8	4.9	6.0	7.1	2.297	2.422	2.845
M2.5x0.45	2.90	3.40	2.792	2.832	2.847	3.0	4.2	5.5	6.7	8.0	2.597	2.722	3.145
M3x0.5	3.40	4.00	3.325	3.367	3.384	3.5	5.0	6.5	8.0	9.5	3.108	3.248	3.716
M3.5x0.6	4.10	4.70	3.890	3.940	3.959	4.1	5.9	7.6	9.4	11.1	3.630	3.790	4.354
M4x0.7	4.70	5.30	4.455	4.509	4.529	4.7	6.7	8.7	10.7	12.7	4.152	4.332	5.007
M5x0.8	5.80	6.40	5.520	5.577	5.597	5.8	8.3	10.8	13.3	15.8	5.174	5.374	6.145
M6x1	7.10	7.70	6.650	6.719	6.742	7.0	10.0	13.0	16.0	19.0	6.217	6.407	7.422
M7x1	8.10	8.70	7.650	7.719	7.742	8.0	11.5	15.0	18.5	22.0	7.217	7.407	8.422
M8x1.25	9.50	10.10	8.812	8.886	8.911	9.3	13.3	17.3	21.3	25.3	8.271	8.483	9.787
M10x1.5	11.80	12.40	10.974	11.061	11.089	11.5	16.5	21.5	26.5	31.5	10.324	10.560	12.131
M12x1.75	14.20	14.80	13.137	13.236	13.271	13.8	19.8	25.8	31.8	37.8	12.379	12.644	14.478
M14x2	16.50	17.10	15.299	15.406	15.444	16.0	23.0	30.0	37.0	44.0	14.433	14.733	16.822
M16x2	18.50	19.10	17.299	17.406	17.444	18.0	26.0	34.0	42.0	50.0	16.433	16.733	18.822
M18x2.5	21.20	21.80	19.624	19.738	19.778	20.5	29.5	38.5	47.5	56.5	18.541	18.896	21.513
M20x2.5	23.20	23.80	21.624	21.738	21.778	22.5	32.5	42.5	52.5	62.5	20.541	20.896	23.513
M22x2.5	25.20	25.50	23.624	23.738	23.778	24.5	35.5	46.5	57.5	68.5	22.541	22.896	25.513
M24x3	27.90	28.50	25.948	26.093	26.135	27.0	39.0	51.0	63.0	75.0	24.649	25.049	28.238
M27x3	30.90	31.50	28.948	29.093	29.135	30.0	43.5	57.0	70.5	84.0	27.649	28.049	31.238
M30x3.5	34.60	35.20	32.273	32.428	32.472	33.5	48.5	63.5	78.5	93.5	30.757	31.207	34.925
M33x3.5	37.60	38.20	35.273	35.428	35.472	36.5	53.0	69.5	86.0	102.5	33.757	34.207	37.925
M36x4	41.30	41.90	38.598	38.763	38.809	40.0	58.0	76.0	94.0	112.0	36.866	37.341	41.615
M39x4	44.30	44.90	41.598	41.763	41.809	43.0	62.5	82.0	101.5	121.0	39.866	40.341	44.615
METRIC FINE													
M8x1	9.10	9.70	8.650	8.719	8.742	9.0	13.0	17.0	21.0	25.0	8.217	8.407	9.422
M10x1	11.10	11.70	10.650	10.719	10.742	11.0	16.0	21.0	26.0	31.0	10.217	10.407	11.422
M10x1.25	11.50	12.10	10.812	10.886	10.911	11.3	16.3	21.3	26.3	31.3	10.271	10.483	11.787
M12x1.25	13.50	14.10	12.812	12.898	12.926	13.3	19.3	25.3	31.3	37.3	12.271	12.483	13.787
M12x1.5	13.80	14.40	12.974	13.067	13.099	13.5	19.5	25.5	31.5	37.5	12.324	12.560	14.131
M14x1.5	15.80	16.40	14.974	15.067	15.099	15.5	22.5	29.5	36.5	43.5	14.324	14.560	16.131
M16x1.5	17.80	18.40	16.974	17.067	17.099	17.5	25.5	33.5	41.5	49.5	16.324	16.560	18.131
M18x1.5	19.80	20.40	18.974	19.067	19.099	19.5	28.5	37.5	46.5	55.5	18.324	18.560	20.131
M20x1.5	21.80	22.40	20.974	21.067	21.099	21.5	31.5	41.5	51.5	61.5	20.324	20.560	22.131
M22x1.5	23.80	24.40	22.974	23.067	23.099	23.5	34.5	45.5	56.5	67.5	22.324	22.560	24.131
M18x2	20.50	21.10	19.299	19.406	19.444	20.0	29.0	38.0	47.0	56.0	18.433	18.733	20.822
M20x2	22.50	23.10	21.299	21.406	21.444	22.0	32.0	42.0	52.0	62.0	20.433	20.733	22.822
M22x2	24.50	25.10	23.299	23.406	23.444	24.0	35.0	46.0	57.0	68.0	22.433	22.733	24.822
M24x2	26.50	27.10	25.299	25.414	25.454	26.0	38.0	50.0	62.0	74.0	24.433	24.733	26.822
M27x2	29.50	30.10	28.299	28.414	28.454	29.0	42.5	56.0	69.5	83.0	27.433	27.733	29.822
M30x2	32.50	33.10	31.299	31.414	31.454	32.0	47.0	62.0	77.0	92.0	30.433	30.733	32.822
M33x2	35.50	36.10	34.299	34.414	34.454	35.0	51.5	68.0	84.5	101.0	33.433	33.733	35.822
M36x2	38.50	39.10	37.299	37.414	37.454	38.0	56.0	74.0	92.0	110.0	36.433	36.733	38.822
M39x2	41.50	42.10	40.299	40.414	40.454	41.0	60.5	80.0	99.5	119.0	39.433	39.733	41.822
M36x3	39.90	40.50	37.948	38.093	38.135	39.0	57.0	75.0	93.0	111.0	36.649	37.049	40.238
M39x3	42.90	43.50	40.948	41.093	41.135	42.0	61.5	81.0	100.5	120.0	39.649	40.049	43.238

HeliCoil® STI Tap Part Numbers – Inch

STRAIGHT FLUTE TAPS. Widely used for general hand and machine tapping operations. Available in sizes up to 1-1/2".

- » **Plug Style – (4 Thread Chamfer).** Used in thru holes and blind holes that allow for ample chip clearance. Easier to start and require less tapping torque than bottoming taps.
- » **Bottoming Style – (2 Thread Chamfer).** Used in blind holes drilled to a minimum depth that requires threads be close to the bottom of the hole.

SPIRAL POINTED – PLUG & SPIRAL FLUTE. Used for efficient chip disposal in production tapping operations. Available in sizes up to 1/2".

- » **Spiral Pointed – Plug (4 Thread Chamfer).** Widely used in long thru holes and blind holes with ample chip clearance. Incorporates an angular grind at the point end of the tap which shears chips and drives them forward of the tap. They are free cutting and provide increased tap strength. Not recommended for abrasive materials.

TABLE IX – HELI-COIL STI TAP PART NUMBERS

Nominal Thread Size	Straight Flute				Spiral Point		High Spiral Flute		Roughing Tap
	Plug		Bottoming		Plug		Bottoming		
	3B	2B	3B	2B	3B	2B	3B	2B	
UNIFIED COARSE THREAD (UNC)									
1 (.073)-64	01CPB	01CPA	01CBB	01CBA	01CSB	01CSA	5905-01	6905-01	
2 (.086)-56	02CPB	02CPA	02CBB	02CBA	02CSB	02CSA	5905-02	6905-02	
3 (.099)-48	03CPB	03CPA	03CBB	03CBA	03CSB	03CSA	5905-03	6905-03	
4 (.112)-40	04CPB	04CPA	04CBB	04CBA	04CSB	04CSA	5905-04	6905-04	
5 (.125)-40	05CPB	05CPA	05CBB	05CBA	05CSB	05CSA	5905-05	6905-05	
6 (.138)-32	06CPB	06CPA	06CBB	06CBA	06CSB	06CSA	5905-06	6905-06	
8 (.164)-32	2CPB	2CPA	2CBB	2CBA	2CSB	2CSA	5905-2	6905-2	
10 (.190)-24	3CPB	3CPA	3CBB	3CBA	3CSB	3CSA	5905-3	6905-3	
12 (.216)-24	1CPB	1CPA	1CBB	1CBA	1CSB	1CSA	5905-1	6905-1	
1/4 (.2500)-20	4CPB	4CPA	4CBB	4CBA	4CSB	4CSA	5905-4	6905-4	
5/16 (.3125)-18	5CPB	5CPA	5CBB	5CBA	5CSB	5CSA	5905-5	6905-5	
3/8 (.3750)-16	6CPB	6CPA	6CBB	6CBA	6CSB	6CSA	5905-6	6905-6	
7/16 (.4375)-14	7CPB	7CPA	7CBB	7CBA	7CSB	7CSA	5905-7	6905-7	7CRU
1/2 (.5000)-13	8CPB	8CPA	8CBB	8CBA	8CSB	8CSA	5905-8	6905-8	8CRU
9/16 (.5625)-12	187-9	38187-9	4187-9	43187-9					9CRU
5/8 (.6250)-11	8187-10	18187-10	10187-10	20187-10					10CRU
3/4 (.7500)-10	8187-12	18187-12	10187-12	20187-12					12CRU
7/8 (.8750)-9	8187-14	18187-14	10187-14	20187-14					14CRU
1 (1.0000)-8	8187-16	18187-16	10187-16	20187-16					16CRU
1-1/8 (1.1250)-7	8187-18	18187-18	10187-18	20187-18					
1-1/4 (1.2500)-7	8187-20	18187-20	10187-20	20187-20					
1-3/8 (1.3750)-6	8187-22	18187-22	10187-22	20187-22					
1-1/2 (1.5000)-6	8187-24	18187-24	10187-24	20187-24					
UNIFIED FINE THREAD (UNF)									
2 (.086)-64	02FPB	02FPA	02FBB	02FBA	02FSB	02FSA	5906-02	6906-02	
3 (.099)-56	03FPB	03FPA	03FBB	03FBA	03FSB	03FSA	5906-03	6906-03	
4 (.112)-48	04FPB	04FPA	04FBB	04FBA	04FSB	04FSA	5906-04	6906-04	
6 (.138)-40	06FPB	06FPA	06FBB	06FBA	06FSB	06FSA	5906-06	6906-06	
8 (.164)-36	2FPB	2FPA	2FBB	2FBA	2FSB	2FSA	5906-2	6906-2	
10 (.190)-32	3FPB	3FPA	3FBB	3FBA	3FSB	3FSA	5906-3	6906-3	
1/4 (.2500)-28	4FPB	4FPA	4FBB	4FBA	4FSB	4FSA	5906-4	6906-4	
5/16 (.3125)-24	5FPB	5FPA	5FBB	5FBA	5FSB	5FSA	5906-5	6906-5	
3/8 (.3750)-24	6FPB	6FPA	6FBB	6FBA	6FSB	6FSA	5906-6	6906-6	
7/16 (.4375)-20	7FPB	7FPA	7FBB	7FBA	7FSB	7FSA	5906-7	6906-7	7FRU
1/2 (.5000)-20	8FPB	8FPA	8FBB	8FBA	8FSB	8FSA	5906-8	6906-8	8FRU
9/16 (.5625)-18	38193-9	18193-9	43193-9	20193-9					9FRU
5/8 (.6250)-18	8193-10	18193-10	10193-10	20193-10					10FRU
3/4 (.7500)-16	8193-12	18193-12	10193-12	20193-12					12FRU
7/8 (.8750)-14	8193-14	18193-14	10193-14	20193-14					14FRU
1 (1.0000)-14	8193-16	18193-16	10193-16	20193-16					16FRU
1 (1.0000)-12	8193-161	18193-161	10193-161	20193-161					161FRU
1-1/8 (1.1250)-12	8193-18	18193-18	10193-18	20193-18					
1-1/4 (1.2500)-12	8193-20	18193-20	10193-20	20193-20					
1-3/8 (1.3750)-12	8193-22	18193-22	10193-22	20193-22					
1-1/2 (1.5000)-12	8193-24	18193-24	10193-24	20193-24					

» **High Spiral Flute – Bottoming (2 Thread Chamfer)**. Have spiral flute for efficiently pulling stringy chips out of deep or blind holes in soft materials.

ROUGHING TAPS. Are available for difficult tapping operations where it is desirable to reduce the load on the finishing tap. Available in sizes 7/16 – 1".

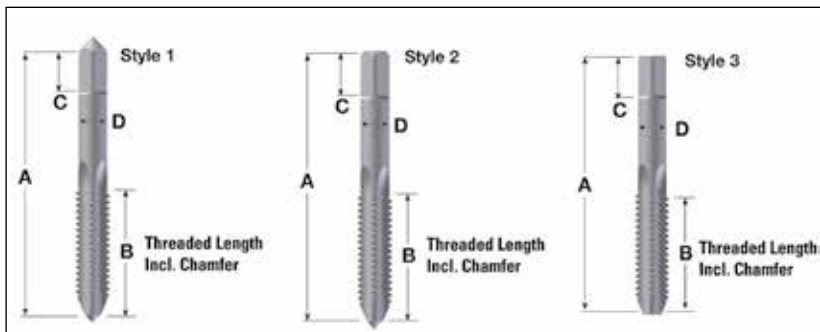

TABLE X – HELI-COIL STI TAP DIMENSIONS

Nominal Thread Size	Tap Dimensions					Number of Flutes			Tap Style*	H Limits	
	Length Overall A	Length of Thread B	Length of Square C	Max Dia of Shank D	Max Size of Square	Straight Flute	Spiral Point Plug	Spiral Flute Bott.		3B	2B
UNIFIED COARSE THREAD (UNC)											
1 (.073)-64	1-13/16	1/2	3/16	.141	.110	3	2	2	1	H1	H2
2 (.086)-56	1-7/8	9/16	3/16	.141	.110	3	2	2	1	H1	H2
3 (.099)-48	1-15/16	5/8	3/16	.141	.110	3	2	2	1	H1	H2
4 (.112)-40	2	11/16	3/16	.141	.110	3	2	2	1	H1	H2
5 (.125)-40	2-1/8	3/4	1/4	.168	.131	3	2	3	1	H1	H2
6 (.138)-32	2-3/8	7/8	1/4	.194	.152	3	2	3	1	H2	H3
8 (.164)-32	2-3/8	15/16	9/32	.220	.165	3	2	3	1	H2	H3
10 (.190)-24	2-1/2	1	5/16	.255	.191	3	2	3	2	H2	H3
12 (.216)-24	2-23/32	1-1/8	3/8	.318	.238	3	2	3	2	H2	H3
1/4 (.2500)-20	2-23/32	1-1/8	3/8	.318	.238	3	2	3	2	H2	H3
5/16 (.3125)-18	2-15/16	1-1/4	7/16	.381	.286	4	3	3	2	H3	H4
3/8 (.3750)-16	3-3/8	1-21/32	7/16	.367	.275	4	3	3	3	H3	H4
7/16 (.4375)-14	3-19/32	1-21/32	1/2	.429	.322	4	3	4	3	H3	H4
1/2 (.5000)-13	3-13/16	1-13/16	9/16	.480	.360	4	3	4	3	H3	H4
9/16 (.5625)-12	4-1/32	1-13/16	5/8	.542	.406	4			3	H3	H4
5/8 (.6250)-11	4-1/4	2	11/16	.590	.442	4			3	H3	H4
3/4 (.7500)-10	4-11/16	2-7/32	3/4	.697	.523	4			3	H3	H5
7/8 (.8750)-9	5-1/8	2-1/2	13/16	.800	.600	4			3	H3	H5
1 (1.000)-8	5-3/4	2-9/16	1	1.021	.766	4			3	H4	H6
1-1/8 (1.1250)-7	6-1/16	3	1-1/16	1.108	.831	4			3	H4	H6
1-1/4 (1.2500)-7	6-3/8	3	1-1/8	1.233	.925	4			3	H4	H6
1-3/8 (1.3750)-6	6-11/16	3-3/16	1-1/8	1.305	.979	6			3	H6	H8
1-1/2 (1.5000)-6	7	3-3/16	1-1/4	1.430	1.072	6			3	H6	H8
UNIFIED FINE THREAD (UNF)											
2 (.086)-64	1-7/8	9/16	3/16	.141	.110	3	2	2	1	H1	H2
3 (.099)-56	1-15/16	5/8	3/16	.141	.110	3	2	2	1	H1	H2
4 (.112)-48	2	11/16	3/16	.141	.110	3	2	2	1	H1	H2
6 (.138)-40	2-1/8	3/4	1/4	.168	.131	3	2	3	1	H1	H2
8 (.164)-36	2-3/8	15/16	9/32	.220	.165	3	2	3	1	H1	H2
10 (.190)-32	2-1/2	1	5/16	.255	.191	3	2	3	2	H2	H3
1/4 (.2500)-28	2-23/32	1-1/8	3/8	.318	.238	3	2	3	2	H2	H3
5/16 (.3125)-24	2-15/16	1-1/4	7/16	.381	.286	4	3	3	2	H2	H3
3/8 (.3750)-24	3-5/32	1-7/16	13/32	.323	.242	4	3	3	3	H2	H3
7/16 (.4375)-20	3-3/8	1-21/32	7/16	.367	.275	4	3	3	3	H3	H4
1/2 (.5000)-20	3-19/32	1-21/32	1/2	.429	.322	4	3	4	3	H3	H4
9/16 (.5625)-18	3-13/16	1-13/16	9/16	.480	.360	4			3	H3	H4
5/8 (.6250)-18	4-1/32	1-13/16	5/8	.542	.406	4			3	H3	H4
3/4 (.7500)-16	4-15/32	2	11/16	.652	.489	4			3	H3	H4
7/8 (.8750)-14	5-1/8	2-1/2	13/16	.800	.600	4			3	H3	H4
1 (1.0000)-14	5-7/16	2-9/16	7/8	.896	.672	4			3	H4	H6
1 (1.0000)-12	5-7/16	2-9/16	7/8	.896	.672	4			3	H4	H6
1-1/8 (1.1250)-12	5-3/4	2-9/16	1	1.021	.766	6			3	H4	H6
1-1/4 (1.2500)-12	6-1/16	3	1-1/16	1.108	.831	6			3	H4	H6
1-3/8 (1.3750)-12	6-3/8	3	1-1/8	1.233	.925	6			3	H4	H6
1-1/2 (1.5000)-12	6-11/16	3-3/16	1-1/8	1.305	.979	6			3	H4	H6

• All bottoming taps have male center on thread end removed.

HeliCoil® STI Tap Part Numbers – Metric

STRAIGHT FLUTE TAPS.

Widely used for general hand and machine tapping operations.
Available in sizes up to 39mm.

» Plug Style – (4 Thread Chamfer).

Used in thru holes and in blind holes that allow for ample chip clearance. Easier to start and require less tapping torque than bottoming taps.

» Bottoming Style – (2 Thread Chamfer).

Used in blind holes drilled to a minimum depth that requires threads be close to the bottom of the hole.

SPIRAL POINTED – PLUG & SPIRAL FLUTE.

Used for efficient chip disposal in production tapping operations.
Available in sizes up to 12mm.

» Spiral Pointed – Plug (4 Thread Chamfer).

Used widely in long thru holes and blind holes with ample chip clearance. Incorporates an angular grind at the point end of the tap which shears chips and drives them forward of the tap. They are free cutting and provide increased tap strength.
Not recommended for abrasive materials.

TABLE XI – HELI-COIL STI TAP PART NUMBERS

Nominal Thread Size	Straight Flute				Spiral Point		High Spiral Flute		Roughing Tap
	Plug		Bottoming		Plug		Bottoming		
	4H5H	5H	4H5H	5H	4H5H	5H	4H5H	5H	

METRIC COARSE

M2x0.4	4687-2	2087-2	4693-2	2093-2	4863-2	4763-2	5081-2	4681-2	
M2.2x0.45	4687-2.2	2087-2.2	4693-2.2	2093-2.2	4863-2.2	4763-2.2	5081-2.2	4681-2.2	
M2.5x0.45	4687-2.5	2087-2.5	4693-2.5	2093-2.5	4863-2.5	4763-2.5	5081-2.5	4681-2.5	
M3x0.5	4687-3	2087-3	4693-3	2093-3	4863-3	4763-3	5081-3	4681-3	
M3.5x0.6	4687-3.5	2087-3.5	4693-3.5	2093-3.5	4863-3.5	4763-3.5	5081-3.5	4681-3.5	
M4x0.7	4687-4	2087-4	4693-4	2093-4	4863-4	4763-4	5081-4	4681-4	
M5x0.8	4687-5	2087-5	4693-5	2093-5	4863-5	4763-5	5081-5	4681-5	
M6x1	4687-6	2087-6	4693-6	2093-6	4863-6	4763-6	5081-6	4681-6	
M7x1	4687-7	2087-7	4693-7	2093-7	4863-7	4763-7	5081-7	4681-7	
M8x1.25	4687-8	2087-8	4693-8	2093-8	4863-8	4763-8	5081-8	4681-8	
M10x1.5	4687-10	2087-10	4693-10	2093-10	4863-10	4763-10	5081-10	4681-10	
M12x1.75	4687-12	2087-12	4693-12	2093-12	4863-12	4763-12	5081-12	4681-12	3765-12
M14x2	4687-14	2087-14	4693-14	2093-14					3765-14
M16x2	4687-16	2087-16	4693-16	2093-16					3765-16
M18x2.5	4687-18	2087-18	4693-18	2093-18					3765-18
M20x2.5	4687-20	2087-20	4693-20	2093-20					3765-20
M22x2.5	4687-22	2087-22	4693-22	2093-22					3765-22
M24x3	4687-24	2087-24	4693-24	2093-24					3765-24
M27x3	4687-27	2087-27	4693-27	2093-27					
M30x3.5	4687-30	2087-30	4693-30	2093-30					
M33x3.5	4687-33	2087-33	4693-33	2093-33					
M36x4	4687-36	2087-36	4693-36	2093-36					
M39x4	4687-39	2087-39	4693-39	2093-39					

METRIC FINE

M8x1	5484-8	4984-8	5486-8	4986-8	4864-8	4764-8	5066-8	4666-8	
M10x1	5484-10	4984-10	5486-10	4986-10	4864-10	4764-10	5066-10	4666-10	
M10x1.25	5444-10	4944-10	5445-10	4945-10	4865-10	4765-10	5067-10	4667-10	
M12x1.25	5444-12	4944-12	5445-12	4945-12	4865-12	4765-12	5067-12	4667-12	3767-12
M12x1.5	5476-12	4976-12	5477-12	4977-12	4866-12	4766-12	5068-12	4668-12	3768-12
M14x1.5	5476-14	4976-14	5477-14	4977-14					3768-14
M16x1.5	5476-16	4976-16	5477-16	4977-16					3768-16
M18x1.5	5476-18	4976-18	5477-18	4977-18					3768-18
M20x1.5	5476-20	4976-20	5477-20	4977-20					3768-20
M22x1.5	5476-22	4976-22	5477-22	4977-22					3768-22
M18x2	5490-18	4990-18	5492-18	4992-18					3769-18
M20x2	5490-20	4990-20	5492-20	4992-20					3769-20
M22x2	5490-22	4990-22	5492-22	4992-22					3769-22
M24x2	5490-24	4990-24	5492-24	4992-24					3769-24
M27x2	5490-27	4990-27	5492-27	4992-27					
M30x2	5490-30	4990-30	5492-30	4992-30					
M33x2	5490-33	4990-33	5492-33	4992-33					
M36x2	5490-36	4990-36	5492-36	4992-36					
M39x2	5490-39	4990-39	5492-39	4992-39					
M36x3	5496-36	4996-36	5497-36	4997-36					
M39x3	5496-39	4996-39	5497-39	4997-39					

» High Spiral Flute – Bottoming (2 Thread Chamfer).

Have spiral flute for efficiently pulling stringy chips out of deep or blind holes in soft materials.

ROUGHING TAPS.

Are available for difficult tapping operations where it is desirable to reduce the load on the finishing tap. Available in sizes 12mm thru 24mm.

CUSTOM STI TAPS (Inch and Metric Series)

Taps made to alternate limits, configurations, or to cut difficult materials, or for very high production are available upon request. The following data should be provided at the time of ordering:

- » Thread size
- » Finished hole class of fit. Example: 4H5H, 3B, custom pre-plate requirements.
- » Material to be cut, and its hardness.

- » Hole configuration. Example: Thru or Blind including length of drilled and tapped hole.
- » Type tap. Example: Plug or Bottoming Straight Flute, Spiral Point, Spiral Flute.
- » Special features. Example: Length, Shank Diameter, Chamfer Length, Tap Material.
- » Special coating of tap.

TABLE XII– HELI-COIL STI TAP DIMENSIONS

Nominal Thread Size	Tap Dimensions					Number of Flutes			Tap Style*	H Limits	
	Length Overall A	Length Of Thread B	Length Of Square C	Max Dia Of Shank D	Max Size Of Square	Straight Flute	Spiral Point Plug	Spiral Flute Bott.		4H5H	5H
METRIC COARSE											
M2x0.4	46.04	12.70	4.77	3.62	2.90	3	2	2	1	H1	H2
M2.2X0.45	47.62	14.29	4.76	3.62	2.89	3	2	2	1	H1	H2
M2.5x0.45	49.21	15.88	4.76	3.62	2.89	3	2	2	1	H1	H2
M3x0.5	50.80	17.46	4.76	3.62	2.89	3	2	2	1	H1	H2
M3.5x0.6	53.98	19.05	6.35	4.31	3.43	3	3	3	1	H1	H2
M4x0.7	60.32	22.22	6.35	4.97	3.96	3	3	3	1	H2	H3
M5x0.8	63.50	25.40	7.94	6.52	4.95	3	3	3	2	H2	H3
M6x1	69.06	28.58	9.52	8.12	6.14	4	3	3	2	H2	H3
M7x1	74.61	31.75	11.11	9.72	7.36	4	3	3	2	H2	H3
M8x1.25	74.61	31.75	11.11	9.72	7.36	4	3	3	2	H2	H3
M10x1.5	85.72	42.07	11.11	9.36	7.08	4	3	3	3	H3	H4
M12x1.75	91.28	42.07	12.70	10.94	8.33	4	3	4	3	H3	H4
M14x2	102.39	46.04	15.88	13.82	10.46	4			3	H3	H5
M16x2	107.95	50.80	17.46	15.04	11.38	4			3	H3	H5
M18x2.5	119.06	56.36	19.05	17.75	13.43	4			3	H3	H5
M20x2.5	124.62	56.36	19.05	19.35	14.63	4			3	H3	H5
M22X2.5	130.18	63.50	20.64	20.37	15.39	4			3	H3	H5
M24X3	138.11	65.09	22.22	22.81	17.27	4			3	H4	H6
M27X3	146.05	65.09	25.40	26.03	19.66	4			3	H4	H6
M30X3.5	153.99	76.20	26.99	28.19	21.31	4			3	H4	H6
M33X3.5	161.92	76.20	28.58	31.37	23.70	6			3	H4	H6
M36X4	177.80	80.96	31.75	36.40	27.43	6			3	H6	H8
M39X4	177.80	80.96	31.75	36.40	27.43	6			3	H6	H8
METRIC FINE											
M8X1	74.61	31.75	11.11	9.72	7.36	4	3	3	3	H2	H3
M10X1	80.71	36.51	10.32	8.24	6.25	4	3	3	3	H2	H3
M10X1.25	85.72	42.07	11.11	9.36	7.08	4	3	3	3	H2	H3
M12X1.25	91.28	42.07	12.70	10.94	8.33	4	3	4	3	H3	H4
M12X1.5	91.28	42.07	12.70	10.94	8.33	4	3	4	3	H3	H4
M14X1.5	96.84	46.04	14.29	12.23	9.29	4			3	H3	H4
M16X1.5	107.95	50.80	17.46	15.04	11.38	4			3	H3	H4
M18X1.5	113.51	50.80	17.46	16.61	12.57	4			3	H3	H4
M20X1.5	119.06	56.36	19.05	17.75	13.43	4			3	H3	H4
M22X1.5	130.18	63.50	20.64	20.37	15.39	4			3	H3	H4
M18X2	113.51	50.80	17.46	16.61	12.57	4			3	H3	H5
M20X2	124.62	56.36	19.05	19.35	14.63	4			3	H3	H5
M22X2	130.18	63.50	20.64	20.37	15.39	4			3	H3	H5
M24X2	130.18	63.50	22.22	22.81	17.27	4			3	H4	H6
M27X2	138.11	65.09	25.40	25.98	19.66	4			3	H4	H6
M30X2	146.05	65.09	26.99	28.19	21.31	4			3	H4	H6
M33X2	153.99	76.20	28.58	31.37	23.70	4			3	H4	H6
M36X2	169.86	80.96	28.58	33.23	25.07	6			3	H6	H8
M39X2	177.80	80.96	31.75	36.40	27.43	6			3	H6	H8
M36X3	169.86	80.96	28.58	33.23	25.07	6			3	H6	H8
M39X3	177.80	80.96	31.75	36.40	27.43	6			3	H6	H8

* See page 23 for dimensional drawings. All bottoming taps have male center on thread end removed.

HeliCoil® Gages – Inch

Is the tapped hole correct?

Accuracy of the finished thread when the insert is installed is dependent upon the accuracy of the tapped hole. If the finished tapped hole gages satisfactorily, the installed insert will be within the thread tolerance.

It is not necessary to gage the installed insert.

After the insert is installed, the GO thread plug gage may not enter freely; however, the insert will always seat itself when the bolt or screw is installed and tightened. (Reference NASM33537).

Gage handles and all gage nibs are marked with the extreme product limits for the particular size and class of fit. (See p. 20-21, Tables VII & VIII, Pitch Diameter Limits.)

When gaging tapped holes which have been thoroughly cleaned or which have a protective finish applied, the gage should always be lubricated with light oil.

HI nib may enter provided a definite drag results on or before 3rd turn from entry – Ref. FED-STD-H28, Screw thread Standards for Federal Services.

Heli-Coil STI Thread Plug Gages for checking the tapped hole are listed in the table at right.

Working gages provide a guaranteed minimum wear allowance on the pitch diameter of the **GO** members of two ten thousandths of an inch (.0002). These gages are recommended for production in sizes 1/2 inch and smaller.

Reference gages have pitch diameters on or close to minimum (basic size). They are essentially laboratory or master gages and should be used in case of conflict between two working gages. Conflict can occur when one of the gages has experienced more use and wear.

Nominal Thread Size	COMPLETE WORKING GAGES		COMPLETE REFERENCE GAGE	
	Suggested for Longer Wear Life		Suggested as Master Gages	
	3B	2B	3B	2B
UNIFIED COARSE THREAD (UNC)				
1 (.073)-64	3688-01	1442-01	1688-01	1440-01
2 (.086)-56	3688-02	1442-02	1688-02	1440-02
3 (.099)-48	3688-03	1442-03	1688-03	1440-03
4 (.112)-40	3688-04	1442-04	1688-04	1440-04
5 (.125)-40	3688-05	1442-05	1688-05	1440-05
6 (.138)-32	3688-06	1442-06	1688-06	1440-06
8 (.164)-32	3688-2	1442-2	1688-2	1440-2
10 (.190)-24	3688-3	1442-3	1688-3	1440-3
12 (.216)-24	3688-1	1442-1	1688-1	1440-1
1/4 (.2500)-20	3688-4	1442-4	1688-4	1440-4
5/16 (.3125)-18	3688-5	1442-5	1688-5	1440-5
3/8 (.3750)-16	3688-6	1442-6	1688-6	1440-6
7/16 (.4375)-14	3688-7	1442-7	1688-7	1440-7
1/2 (.5000)-13	3688-8	1442-8	1688-8	1440-8
9/16 (.5625)-12			1688-9	1440-9
5/8 (.6250)-11			1688-10	1440-10
3/4 (.7500)-10			1688-12	1440-12
7/8 (.8750)-9			1688-14	1440-14
1 (1.000)-8			1688-16	1440-16
1-1/8 (1.1250)-7			1688-18	1440-18
1-1/4 (1.2500)-7			1688-20	1440-20
1-3/8 (1.3750)-6			1688-22	1440-22
1-1/2 (1.5000)-6			1688-24	1440-24
UNIFIED FINE THREAD (UNF)				
2 (.086)-64	3694-02	1443-02	1694-02	1441-02
3 (.099)-56	3694-03	1443-03	1694-03	1441-03
4 (.112)-48	3694-04	1443-04	1694-04	1441-04
6 (.138)-40	3694-06	1443-06	1694-06	1441-06
8 (.164)-36	3694-2	1443-2	1694-2	1441-2
10 (.190)-32	3694-3	1443-3	1694-3	1441-3
1/4 (.2500)-28	3694-4	1443-4	1694-4	1441-4
5/16 (.3125)-24	3694-5	1443-5	1694-5	1441-5
3/8 (.3750)-24	3694-6	1443-6	1694-6	1441-6
7/16 (.4375)-20	3694-7	1443-7	1694-7	1441-7
1/2 (.5000)-20	3694-8	1443-8	1694-8	1441-8
9/16 (.5625)-18			1694-9	1441-9
5/8 (.6250)-18			1694-10	1441-10
3/4 (.7500)-16			1694-12	1441-12
7/8 (.8750)-14			1694-14	1441-14
1 (1.0000)-14			1694-16	1441-16
1 (1.0000)-12			1694-161	1441-161
1-1/8 (1.1250)-12			1694-18	1441-18
1-1/4 (1.2500)-12			1694-20	1441-20
1-3/8 (1.3750)-12			1694-22	1441-22
1-1/2 (1.5000)-12			1694-24	1441-24

HELI-COIL STI GAGE WITH GO & HI MEMBERS



Nominal Thread Size	COMPLETE REFERENCE GAGE	
	4H5H	5H
METRIC COARSE		
M2x0.4	4624-2	1324-2
M2.2X0.45	4624-2.2	1324-2.2
M2.5x0.45	4624-2.5	1324-2.5
M3x0.5	4624-3	1324-3
M3.5x0.6	4624-3.5	1324-3.5
M4x0.7	4624-4	1324-4
M5x0.8	4624-5	1324-5
M6x1	4624-6	1324-6
M7x1	4624-7	1324-7
M8x1.25	4624-8	1324-8
M10x1.5	4624-10	1324-10
M12x1.75	4624-12	1324-12
M14x2	4624-14	1324-14
M16x2	4624-16	1324-16
M18x2.5	4624-18	1324-18
M20x2.5	4624-20	1324-20
M22X2.5	4624-22	1324-22
M24X3	4624-24	1324-24
M27X3	4624-27	1324-27
M30X3.5	4624-30	1324-30
M33X3.5	4624-33	1324-33
M36X4	4624-36	1324-36
M39X4	4624-39	1324-39

METRIC FINE		
M8X1	5416-8	4916-8
M10X1	5416-10	4916-10
M10X1.25	5424-10	4924-10
M12X1.25	5424-12	4924-12
M12X1.5	5480-12	4980-12
M14X1.5	5480-14	4980-14
M16X1.5	5480-16	4980-16
M18X1.5	5480-18	4980-18
M20X1.5	5480-20	4980-20
M22X1.5	5480-22	4980-22
M18X2	5418-18	4918-18
M20X2	5418-20	4918-20
M22X2	5418-22	4918-22
M24X2	5418-24	4918-24
M27X2	5418-27	4918-27
M30X2	5418-30	4918-30
M33X2	5418-33	4918-33
M36X2	5421-36	4921-36
M39X3	5421-39	4921-39

Heli-Coil STI Thread Plug Gages (metric) for checking the tapped hole are listed in chart.

The complete gage consists of the **GO** thread plug gage, the **HI** thread plug gage and the appropriately marked gage handle.

Accuracy of the finished thread, when the insert is installed, is dependent upon the accuracy of the tapped hole. If the finished tapped hole gages satisfactorily, the installed insert will be within the thread tolerance. It is, therefore, **not necessary to gage the installed insert.**

After the insert is installed, the GO thread plug gage may not enter freely; however, the insert will always seat itself when the bolt or screw is installed and tightened. (Reference MA1567)

When gaging tapped holes which have been thoroughly cleaned or which have a protective finish applied, the gage should always be lubricated with light oil.

The HI thread plug gage may enter provided that a definite drag results on or before the second turn of entry. (Reference ANSI B1.16)



TOOLS FOR TANGED INSERTS

Both hand and power tools are available to install tanged inserts. The various tools to install Heli-Coil inserts are presented on the following pages.

For production runs, prototype work, salvage, and repair, hand inserting tools are available. For high volume production, power inserting tools are also available. Both types of tools are dimensioned (p.29 & 31) to aid determination of accessibility to the tapped hole.

Both hand and power inserting tools feature a threaded mandrel which engages the insert and provides a positive lead to guide the insert into the tapped hole easily and quickly.

Power inserting tools consist of an air motor, adapter and front end assembly. The front end assembly consists of a prewinder,

mandrel and 3 spacers (1 for each length of insert to be installed). The versatility and adaptability of Heli-Coil power inserting tools is shown on p. 32. The tool can be hand held, vertically or horizontally mounted, and adapted to both semi-automatic and fully automatic installation stations. Heli-Coil power inserting tools can be adapted to assembly stations, rotary tables and transfer lines.

All Heli-Coil tooling is backed by our extensive expertise and experience in virtually any application. All tools are fully warranted. In addition, our Application Engineering Department is always available to assist in installation techniques and special tooling (longer or shorter length tools, etc.). For very high production, Heli-Coil will provide for the successful development of automated installation systems.

HAND INSTALLATION TOOLS

Heli-Coil manufactures various designs of hand inserting tools.

Generally, finer pitch inserts are proportionately larger in the free state than coarse pitch inserts and thus have to be "pre-wound" to a smaller diameter for installation.

Large coarse pitch inserts need only a threaded mandrel tool for installation.



**TYPE I
Threaded Mandrel**
Ideal for small production runs;
for use with free running and
screw locking inserts.



**TYPE II
Prewinder**
Prewinder reduces the diameter of the
insert to that of the tapped hole allowing
for easy installation.



**TYPE III
Threaded Mandrel**
Inserts are wound onto the mandrel prior to
installation; threads prevent any cross threading.



**TYPE IV
Non-Captive Prewinder**
Similar to Type III but includes a prewinder to
facilitate insert installation process.

Nominal Thread Size	Hand Inserting Tools 3 Dia. Lengths thru 7/8 2 Dia. Lengths 1" & Up	Tool Type
---------------------	---	-----------

UNIFIED COARSE

1 (.073)-64	7551-01	IV
2 (.086)-56	551-02	I
3 (.099)-48	551-03	I
4 (.112)-40*	7551-04	II
5 (.125)-40	7551-05	II
6 (.138)-32	7551-06	II
8 (.164)-32*	7551-2	II
10 (.190)-24*	7551-3 (M)	II
12 (.216)-24	7551-1 (M)	II
1/4 (.2500)-20	7551-4 (M)	II
5/16 (.3125)-18	7551-5 (M)	II
3/8 (.3750)-16	7551-6 (M)	II
7/16 (.4375)-14	7551-7 (M)	II
1/2 (.5000)-13	7551-8 (M)	II
9/16 (.5625)-12	3724-9	III
5/8 (.6250)-11	3724-10	III
3/4 (.7500)-10	3724-12	III
7/8 (.8750)-9	3724-14	III
1 (1.0000)-8	3724-16	III
1-1/8 (1.1250)-7	3724-18	III
1-1/4 (1.2500)-7	3724-20	III
1-3/8 (1.3750)-6	3724-22	III
1-1/2 (1.5000)-6	3724-24	III

UNIFIED FINE

2 (.086)-64	7552-02	IV
3 (.099)-56	7552-03	II
4 (.112)-48	7552-04	II
6 (.138)-40	7552-06	II
8 (.164)-36	7552-2	II
10 (.190)-32	7552-3 (M)	II
1/4 (.2500)-28	7552-4 (M)	II
5/16 (.3125)-24	7552-5 (M)	II
3/8 (.3750)-24	7552-6 (M)	II
7/16 (.4375)-20	7552-7 (M)	II
1/2 (.5000)-20	7552-8 (M)	II
9/16 (.5625)-18	535-9	IV
5/8 (.6250)-18	535-10	IV
3/4 (.7500)-16	535-12	IV
7/8 (.8750)-14	535-14	IV
1 (1.0000)-14	535-16	IV
1 (1.0000)-12	535-161	IV
1-1/8 (1.1250)-12	535-18	IV
1-1/4 (1.2500)-12	535-20	IV
1-3/8 (1.3750)-12	535-22	IV
1-1/2 (1.5000)-12	535-24	IV

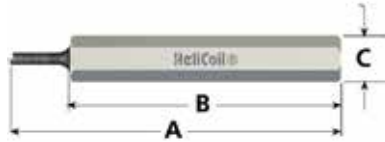

**TYPE I
Threaded Mandrel**

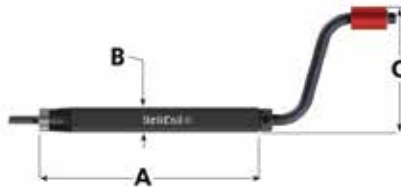

**TYPE II
Prewinder***

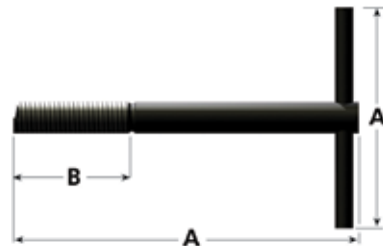

**TYPE III
Threaded Mandrel**

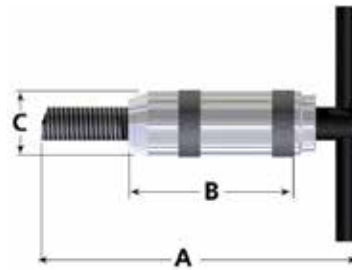

**TYPE IV
Non-Captive Prewinder**

Nominal Thread Size	Hand Inserting Tools 3 Dia. Lengths thru M22 2 Dia. Lengths M24 & Up	Tool Type
---------------------	--	-----------

METRIC COARSE

M2x0.4	7751-2	IV
M2.2x0.45	7751-2.2	I
M2.5x0.45*	7751-2.5	II
M3x0.5*	7751-3	II
M3.5x0.6	7751-3.5	II
M4x0.7	7751-4	II
M5x0.8*	7751-5 (M)	II
M6x1	7751-6 (M)	II
M7x1	7751-7 (M)	II
M8x1.25	7751-8 (M)	II
M10x1.5	7751-10 (M)	II
M12x1.75	7751-12 (M)	II
M14x2	7751-14	IV
M16x2	7751-16	IV
M18x2.5	7751-18	III
M20x2.5	7751-20	IV
M22x2.5	7751-22	III
M24x3	7751-24	III
M27x3	7751-27	III
M30x3.5	7751-30	III
M33x3.5	7751-33	III
M36x4	7751-36	III
M39x4	7751-39	III

METRIC FINE

M8x1	7755-8	II
M10x1	7755-10	II
M10x1.25	7756-10	II
M12x1.25	7756-12	II
M12x1.5	7753-12	II
M14x1.5	7753-14	IV
M16x1.5	7753-16	IV
M18x1.5	7753-18	IV
M20x1.5	7753-20	IV
M22x1.5	7753-22	IV
M18x2	7754-18	IV
M20x2	7754-20	IV
M22x2	7754-22	IV
M24x2	7754-24	IV
M27x2	7754-27	IV
M30x2	7754-30	IV
M33x2	7754-33	IV
M36x2	7754-36	IV
M39x2	7754-39	IV
M36x3	7752-36	IV
M39x3	7752-39	IV

* Special tools required to install Phosphor Bronze and Inconel X-750 inserts in these sizes. To order add "-9" to the part number shown.
Note: Inserts marked with an "(M)" are available with a steel prewinder.
For this option, specify when ordering (e.g., 7551-3M).

HAND INSERTING TOOL DIMENSIONS

INCH	METRIC	A	B	C	INCH	METRIC	A	B	C	INCH	METRIC	A	B	C
TYPE I - Coarse & Fine					TYPE II - Coarse & Fine (continued)					TYPE IV - Coarse & Fine*				
2	M2.2	2-7/16	2	5/16	7/16"	M10 & 11	5-1/4	25/32	3-23/32	9/16"	M14*	5-3/8	2-7/8	1-1/8
3		6	3	5/8	1/2"	M12	5-1/2	7/8	3-23/32	5/8"	M16*	5-3/8	2-7/8	1-1/8
TYPE II - Coarse & Fine					TYPE III - Coarse					3/4"	M18	6	2-7/8	1-1/2
4	M2.5	4-5/8	3/8	2-9/32	9/16"		4-7/8	1-13/16	4	7/8"	M20	6-3/8	2-7/8	1-1/2
5	M3	4-5/8	3/8	2-9/32	5/8"		4-7/8	2	4	1-14"	M22	5-7/8	2-7/8	1-5/8
6	M3.5	4-5/8	3/8	2-9/32	3/4"	M18	4-7/8	2-3/8	4	1-12"	M24	5-7/8	2-7/8	1-5/8
8	M4	4-5/8	3/8	2-9/32	7/8"	M20	4-7/8	2-3/4	4-1/2	1-1/8"	M30	6-5/16	3-1/16	2
10	M5	4-5/8	15/32	2-9/32	1"	M24	4-7/8	2-1/8	4-1/2	1-1/4"	M33	6-13/16	3-5/16	2
12		4-5/8	33/64	2-17/32	1-1/8"	M30	6-3/4	2-1/2	6	1-3/8"	M36	7-5/16	3-9/16	2-1/4
1/4"	M6	4-5/8	33/64	2-17/32	1-1/4"	M33	6-3/4	2-3/4	6	1-1/2"	M39	7-13/16	3-13/16	2-1/4
5/16"		4-5/8	5/8	3-23/32	1-3/8"	M36	6-3/4	3	6	1-64	M2	2-5/8	3/4	7/16
3/8"	M7 & 8	5	45/64	3-23/32	1-1/2"	M39	6-3/4	3-1/4	6					

* M14 & M16 Coarse are Type IV Tools. For metric sizes not shown, see next largest size.

HeliCoil® Tanged Power Installation Tools – Inch

Heli-Coil power tools are available in Inch and Metric sizes #2 (M2.2) thru 1/2" * (M12) for rapid installation of Heli-Coil inserts. Power tools consist of a **Front End Assembly**, an **Adapter** and a reversible **Air Motor**. All three components are ordered separately.

A Front End Assembly consists of a prewinder, mandrel and spacers. Select the adapter that corresponds with the insert size being used. Power tools for strip feed inserts are available in sizes #2 (M2.2) through 5/16" (M6).

Nominal Thread Size	FRONT END ASSEMBLY		PREWINDERS		MANDRELS	SPACERS			
	P/N for Bulk Inserts (2 dia. max.)	P/N for Strip Feed Inserts	P/N for Bulk Inserts	P/N for Strip Feed Inserts		1 Dia.	1-1/2 Dia.	2 Dia.	
UNIFIED COARSE THREAD (UNC)									
Small Adapter	2 (.086)-56		8551-02-15		8557-02-15	8553-02	8559-02	8560-02	8561-02
	4 (.112)-40	8551-04	8551-04-15	8557-04	8557-04-15	8553-04	8559-04	8560-04	8561
	5 (.125)-40	8551-05		8557-05		8553-05	8559-05	8560-05	8561
	6 (.138)-32	8551-06	8551-06-15	8557-06	8557-06-15	8553-06	8559-06	8560-06	8561
	8 (.164)-32	8551-2	8551-2-15	8557-2	8557-2-15	8553-2	8559-2	8560-2	8561
	10 (.190)-24	8551-3	8551-3-15	8557-3	8557-3-15	8553-3	8559-3	8560-3	8561
Large Adapter	1/4 (.2500)-20	8551-4	8551-4-15	8557-4	8557-4-15	8553-4	8559-4	8560-4	8561
	5/16 (.3125)-18	8251-5	8251-5-15	8257-5	8257-5-15	8253-5	8259-5-10	8259-5-15	
	3/8 (.3750)-16	8251-6		8257-6		8253-6	8259-6-10	8259-6-15	NONE
	7/16 (.4375)-14	8251-7		8257-7		8253-7	8259-7-10	8259-7-15	REQ'D
	1/2 (.5000)-13	8251-8		8257-8		8253-8	8259-8-10	8259-8-15	
UNIFIED FINE THREAD (UNF)									
Small Adapter	6 (.138)-40	8552-06		8558-06		8554-06	8559-06	8560-06	8561
	10 (.190)-32	8552-3	8552-3-15	8558-3	8558-3-15	8554-3	8559-3	8560-3	8561
	1/4 (.2500)-28	8552-4	8552-4-15	8558-4	8558-4-15	8554-4	8559-4	8560-4	8561
Large Adapter	5/16 (.3125)-24	8252-5	8252-5-15	8258-5	8258-5-15	8254-5	8259-5-10	8259-5-15	
	3/8 (.3750)-24	8252-6		8258-6		8254-6	8259-6-10	8259-6-15	NONE
	7/16 (.4375)-20	8252-7		8258-7		8254-7	8259-7-10	8259-7-15	REQ'D
	1/2 (.5000)-20	8252-8		8258-8		8254-8	8259-8-10	8259-8-15	

*Tools for larger sizes or special applications are available upon request.

Pneumatic Power Tool



Complete Power Tool (Assembled)
(All parts are ordered separately)



Air Motor 8510-1

ADAPTERS



Small 8550R
(Sizes < 1/4")



Large 8550-1R
(Sizes > 1/4")

FRONT END ASSEMBLY



Prewinder

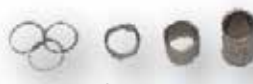

Spacers



Mandrel



Power Tool Holder, **Part No. 23537**, can be used with or without Strip Feed inserts (with the exception of 2-56 which is used only on strip).

Note: Recommended for use with **2-56, M2.2x0.45 & M2.5x0.45** power tool.

Tanged Power Installation Tools – Metric **HeliCoil**[®]

Heli-Coil metric power inserting tools are available in coarse and fine sizes up to 12mm* for rapid installation of standard and screw-lock inserts, substantially reducing assembly costs. Strip feed power tools are available in sizes up to 7mm. They speed up assembly, eliminate waste and permit an accurate count.

Power tools consist of a **Front End Assembly**, an **Adapter** and a reversible **Air Motor**. All three components are ordered individually. A front end assembly consists of a prewinder, mandrel and spacers. Select an Adapter that is compatible with the insert size to be used, and for the size range up thru 6mm or the size range 7mm thru 12mm.

Nominal Thread Size	FRONT END ASSEMBLY		PREWINDERS		MANDRELS	SPACERS		
	P/N for Bulk Inserts (2 dia. max.)	P/N for Strip Feed Inserts	P/N for Bulk Inserts	P/N for Strip Feed Inserts		1 Dia.	1-1/2 Dia.	2 Dia.

METRIC COARSE

Small Adapter	M2.2x0.45		8751-2.2-15		8769-2.2-15	8757-2.2	8775-2.2	8776-2.2	8777-2.2
	M2.5x0.45	8751-2.5	8751-2.5-15	8769-2.5	8769-2.5-15	8757-2.5	8775-2.5	8776-2.5	8777
	M3x0.5	8751-3	8751-3-15	8769-3	8769-3-15	8757-3	8775-3	8776-3	8777
	M3.5x0.6	8751-3.5	8751-3.5-15	8769-3.5	8769-3.5-15	8757-3.5	8775-3.5	8776-3.5	8777
	M4x0.7	8751-4	8751-4-15	8769-4	8769-4-15	8757-4	8775-4	8776-4	8777
	M5x0.8	8751-5	8751-5-15	8769-5	8769-5-15	8757-5	8775-5	8776-5	8777
Large Adapter	M6x1	8751-6	8751-6-15	8769-6	8769-6-15	8757-6	8775-6	8776-6	8777
	M7x1	8751-7	8751-7-15	8769-7	8769-7-15	8757-7	8777-7-10	8777-7-15	
	M8x1.25	8751-8		8769-8		8757-8	8777-8-10	8777-8-15	NONE
	M10x1.5	8751-10		8769-10		8757-10	8777-10-10	8777-10-15	REQ'D
	M12x1.75	8751-12		8769-12		8757-12	8777-12-10	8777-12-15	

METRIC FINE

Large Adapter	M8x1	8755-8		8770-8		8764-8	8777-8-10	8777-8-15	
	M10x1	8755-10		8770-10		8764-10	8777-10-10	8777-10-15	NONE
	M10x1.25	8756-10		8758-10		8759-10	8777-10-10	8777-10-15	REQ'D
	M12x1.25	8756-12		8758-12		8759-12	8777-12-10	8777-12-15	
	M12x1.5	8753-12		8773-12		8774-12	8777-12-10	8777-12-15	

*Tools for larger sizes or special applications are available upon request.

For evaluating space required for installing Heli-Coil inserts with standard manual, pneumatic and electronic inserting tools and tang break-off tools, the diagrams on p. 29 & 31 give dimensions of standard Heli-Coil tooling.

For special variations or adaptations, contact our Applications Engineers at (866) 364-2781.

Pneumatic Power Tool

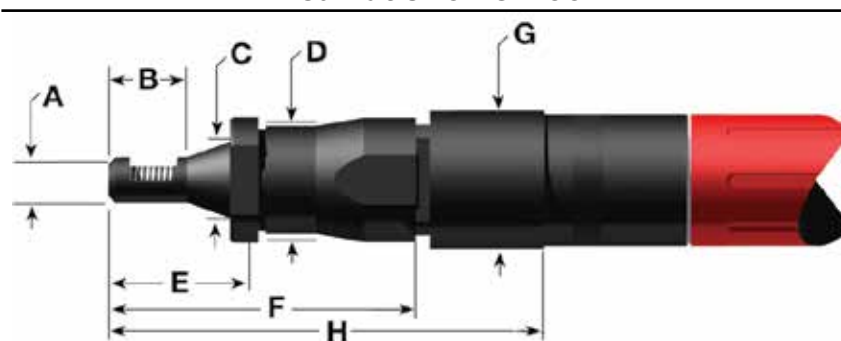

PNEUMATIC POWER TOOL DIMENSIONS

SIZE		A	B	A	B	C	D	E	F	G	H
INCH	METRIC	FOR BULK INSERTS		FOR STRIP FEED INSERTS							
2	M2.2			5/16	7/16	23/32	1-1/8	1-3/8	3-3/16	1-1/4	4-7/16
4	M2.5	1/4	9/16	3/8	15/16	23/32	1-1/8	1-3/8	3-3/16	1-1/4	4-7/16
5	M3	9/32	9/16	3/8	15/16	23/32	1-1/8	1-3/8	3-3/16	1-1/4	4-7/16
6	M3.5	5/16	9/16	1/2	15/16	23/32	1-1/8	1-3/8	3-3/16	1-1/4	4-7/16
8	M4	11/32	9/16	1/2	15/16	23/32	1-1/8	1-3/8	3-3/16	1-1/4	4-7/16
10	M5	3/8	29/32	1/2	15/16	23/32	1-1/8	1-3/8	3-3/16	1-1/4	4-7/16
1/4"	M6	27/64	29/32	5/8	1-3/8	23/32	1-1/8	1-3/8	3-3/16	1-1/4	4-7/16
5/16"	M7 & M8	9/16	1-1/8	11/16	1-1/8	1"	1-9/16	1-3/8	4-7/16	1-1/4	5-3/4
3/8"		11/16	1-11/32			1"	1-9/16	1-7/8	4-3/4	1-1/4	6-1/32
7/16"	M10	3/4	1-17/32			1"	1-9/16	2-1/4	5-1/8	1-1/4	6-13/32
1/2"	M12	13/16	1-25/32			1"	1-9/16	1-1/2	5-13/32	1-1/4	6-11/16

Electronic Power Installation Tool

Heli-Coil offers an electronic power tool where electric power is preferred over air. The slender configuration of the mandrels allows them to reach into constricted areas. Electric power meets the requirements of clean room operations. Operators prefer electric power because it is quieter. The electronic tool is lighter to minimize operator fatigue. Mandrel assemblies are available to install the sizes of Heli-Coil inserts listed in the chart.

Application Note: Variations in Mandrel Assembly dimensions and threads are available on a special order basis. Please contact Heli-Coil Applications Engineering Department at (866) 364-2781 to discuss your application.

Electronic Tool Mandrel Assembly

Insert Thread Size (UNC)	Mandrel Assembly (for bulk inserts)
2 (.086)-56	8051-02
4 (.112)-40	8051-04
6 (.138)-32	8051-06
8 (.164)-32	8051-2
10 (.190)-24	8051-3
10 (.190)-32	10089-3
1/4-20	8051-4

Note: Only available in inch. 10-32 and 1/4-20 require larger driver (P/N 8050-650C).



Pneumatic Power Tool Installation Kit

This Heli-Coil power tool installation kit (8522) contains an Air Motor (8510-1), adapter, tools, a filter-regulator-lubricator, oil, two quick disconnect fittings, and wrenches. All are packed in a portable molded box with easy-to-follow operating instructions. Front End Assemblies may be ordered separately to fit the sizes of Heli-Coil inserts to be installed.

Power Tools Kit Types	Kit Part#	Small Adapter	Large Adapter
Small Adapter Set	8522	✓	
Large Adapter Set	8521		✓
Combination Set	8520	✓	✓

Cordless Electronic Tool

The Heli-Coil Cordless Tool is a complete kit (7200) that includes a driver, 2 batteries (7200-20) and mandrel chuck all in a durable metal box. The cordless tool is portable, lightweight, has adjustable torque and uses standard Heli-Coil electronic tool installation mandrels for quick setup.



Power Tool Holder

The Power Tool Holder 23537 is mounted on a bench and the appropriate air motor is attached to a movable arm. A mounting arm is also provided for attaching reels of strip-feed inserts.

This configuration ensures accurate vertical (square to work surface) installations of Heli-Coil inserts in relatively large parts. The tool holder is capable of installing inserts within a radius of 26 inches as well as on multiple planes.



Note: Recommended for use with the 2-56, M2.2x0.45 and M2.5x0.45 air tools. It also may be used with the Heli-Coil Electronic Inserting Tool.

Heli-Coil Tang Break-Off Tools

The driving tangs of Heli-Coil tanged inserts must be removed to eliminate their interference with the end of the assembled bolt.

Heli-Coil tang break-off tools are available for use with inserts through 1/2 inch and 12mm metric nominal diameter. Their operation is automatic, having a spring loaded, easily triggered punch that strikes a sharp, uniform blow against the tang of the installed insert. The tool can be operated with one hand.



Nominal Thread Size	Tool Part No.	Replacement Punch Part No.	Nominal Thread Size	Tool Part No.	Replacement Punch Part No.
UNIFIED COARSE THREAD (UNC)			METRIC COARSE		
1 (.073)-64	3695-01	3697-01	M2x0.4	4238-2	3697-01
2 (.086)-56	3695-02	3697-02	M2.2x0.45	4238-2.2	3697-02
3 (.099)-48	3695-02	3697-02	M2.5x0.45	4238-2.2	3697-02
4 (.112)-40	3695-04	3697-04	M3x0.5	4238-3	3697-04
5 (.125)-40	3695-04	3697-04	M3.5x0.6	4238-3	3697-04
6 (.138)-32	3695-06	3697-06	M4x0.7	4238-4	3697-2
8 (.164)-32	3695-2	3697-2	M5x0.8	4238-5	3697-3
10 (.190)-24	3695-3	3697-3	M6x1	4238-6	3697-4
12 (.216)-24	3695-3	3697-3	M7x1	4238-7	4436-7
1/4 (.2500)-20	3695-4	3697-4	M8x1.25	4238-8	3643-5
5/16 (.3125)-18	3695-5	3643-5	M10x1.25	4238-10	4436-10
3/8 (.3750)-16	3695-6	3643-6	M12x1.75	4238-12	4436-12
7/16 (.4375)-14	3695-7	3643-7	METRIC FINE		
1/2 (.5000)-13	3695-8	3643-8	M8x1	4238-8	3643-5
UNIFIED FINE THREAD (UNF)			M10x1	4238-10	4436-10
2 (.086)-64	3695-02	3697-02	M10x1.25	4238-10	4436-10
3 (.099)-56	3695-02	3697-02	M12x1.25	4238-12	4436-12
4 (.112)-48	3695-04	3697-04	M12x1.5	4238-12	4436-12
6 (.138)-40	3695-06	3697-06			
8 (.164)-36	3695-2	3697-2			
10 (.190)-32	3695-3	3697-3			
1/4 (.2500)-28	3695-4	3697-4			
5/16 (.3125)-24	3692-5	3645-5			
3/8 (.3750)-24	3692-6	3645-6			
7/16 (.4375)-20	3692-7	3645-7			
1/2 (.5000)-20	3692-8	3645-8			

Note: Tang break-off tools will break-off tangs thru 2 diameter lengths.

For sizes larger than 1/2" or 12mm, use long nose pliers. Bend tang up and down to snap off at notch.

Heli-Coil Extracting Tools

Occasionally Heli-Coil inserts must be removed. Inserts can be removed manually with little effort. This is done by inserting the blade of the extracting tool into the Heli-Coil insert so that the V section of the blade is toward the top end of the insert.



Strike the head of the tool with a light blow. Maintaining a steady pressure of blade against insert, turn the extracting tool counterclockwise until the insert is removed.

Right & wrong blade positions of insert extracting tool.

Nominal Thread Size		Extracting Tool Part No.
Inch	Metric	
1	M2	1227-01
2	M2.2	1227-02
3 thru #8	M2.5 thru M4	1227-06
10 thru 3/8"	M5 thru M10	1227-6
7/16" thru 1"	M11 thru M24	1227-16
1-1/8" thru 1-1/2"	M27 thru M39	1227-24

Top View Shown

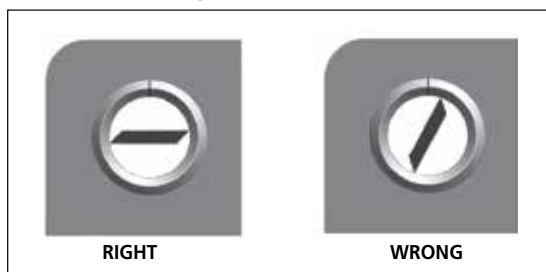

Tangless Installation Tools

Power Tool - Pneumatic Complete Power Tool

For rapid installation of Heli-Coil inserts. A range of front end assemblies are available for use with the power tool, to suit both bulk and strip feed inserts.

Component parts sold separately:

Adapter, Sm (<1/4") 8550R

Adapter, Lg (>1/4") 8550-1R



8510-1

Power Tool - Electronic Electronic Power Inserting Tool

A quieter, lighter Installation Tool - especially suitable for clean room operations. The slender configuration of the gage style mandrel allows easy access to constricted areas.



8050-50

8050-400C
8050-650C

Tangless® Hand Installation Tooling

Nominal Thread Size	Hand Installation Tool		Replacement Installation Blade Kit**		Removal Tool (with handles)	Electronic Driver*	Front End Assembly	Replacement Mandrel Assembly	Replacement Blade
	Crank Style	Gage Style†	Crank Style	Gage Style					
UNIFIED COARSE THREAD (UNC)									
2-56	17551-02	7571-02B	17551-02-5	7571-02-5	7570-02	8050-400C	18551-02-15	18551-02-30	18551-02-2
4-40	17551-04	7571-04B	17551-04-5	7571-04-5	7570-04	8050-400C	18551-04-15	18551-04-30	18551-04-2
6-32	17551-06	7571-06B	17551-06-5	7571-06-5	7570-06	8050-400C	18551-06-15	18551-06-30	18551-06-2
8-32	17551-2	7571-2B	17551-2-5	7571-2-5	7570-2	8050-400C	18551-2-15	18551-2-30	18551-2-2
10-24	17551-3	7571-3B	17551-3-5	7571-3-5	7570-3	8050-650C	18551-3-15	18551-3-30	18551-3-2
1/4-20	17551-4	7571-4B	17551-4-5	7571-4-5	7570-4	8050-650C	18551-4-15	18551-4-30	18551-4-2
UNIFIED FINE THREAD (UNF)									
10-32	17552-3	7572-3B ††	17552-3-5	7572-3-5	7560-3	8050-650C	18552-3-15	18552-3-30	18552-3-2
1/4-28	17552-4	N/A	17552-4-5	N/A	7560-4	8050-650C	18552-4-15	18552-4-30	18552-4-2

* An electronic driver requires a power supply, part number 8050-50.

** Includes blade, spring and pin.

†) Gage style tools must be used with electronic tool. Handle must be removed prior to use with electronic or battery operated drivers.

††) 10-32 gage style tool not recommended for use with electronic driver.

Front End Assembly Dimensions

Nominal Thread Size	A Nose Diameter	B Body Diameter	C Prewinder Tip Length
2-56	.32	.32	.09
4-40	.25	.40	.13
6-32	.32	.50	.14
8-32	.35	.51	.15
10-24	.38	.51	.19
1/4-20	.42	.63	.22
10-32	.38	.51	.15
1/4-28	.42	.63	.22

Installation Tool Dimensions

Nominal Thread Size	A Overall Length (reference)	B Mandrel Length	C Spinner Diameter
2-56	5.33	2.80	.240
4-40	5.43	2.90	.240
6-32	5.53	3.00	.360
8-32	5.68	3.15	.360
10-24	5.53	3.00	.370
1/4-20	5.53	3.00	.370
10-32	5.53	3.00	.370
1/4-28	5.53	3.00	.370

Front End Assembly



Installation mandrel w/handle assembly



Installation mandrel only

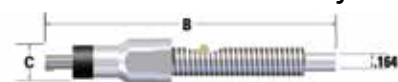

Adjusting/removal tool (shown w/o handle)



Note: Installation mandrel and adjusting/removal tool designed for use with both handle and electronic tool.

Hand Tools

Range includes Prewinder for finer pitch inserts and Threaded Mandrel tools for coarse pitch inserts.



Taps & Gages

Taps and gages are key to ensuring accurate insert installation.



Tangless® Hand Installation Tooling

Tangless® Power Tooling

Nominal Thread Size	Hand Installation Tool Crank Style	Hand Installation Tool Gage Style(†)	Replacement Installation Blade Kit** Crank Style	Replacement Installation Blade Kit** Gage Style	Removal Tool (with handles)	Electronic Driver	Front End Assembly	Replacement Mandrel Assembly	Replacement Blade
---------------------	------------------------------------	--------------------------------------	--	---	-----------------------------	-------------------	--------------------	------------------------------	-------------------

METRIC FREE RUNNING

M2.5x0.45	17751-2.5	7587-2.5	17743-2.5	7587-2.5-2	7595-2.5	8050-400C	38751-2.5-15	38751-2.5-30	38757-2.5
M3x0.5	17751-3	7587-3	17743-3	7587-3-2	7595-3	8050-400C	38751-3-15	38751-3-30	38757-3
M4x0.7	17751-4	7587-4	17743-4	7587-4-2	7595-4	8050-400C	38751-4-15	38751-4-30	38757-4
M5x0.8	17751-5	7587-5	17743-5	7587-5-2	7595-5	8050-400C	38751-5-15	38751-5-30	38757-5
M6x1.0	17751-6	7587-6	17743-6	7587-6-2	7595-6	8050-400C	38751-6-15	38751-6-30	38757-6

METRIC SCREW-LOCKING

M2.5x0.45	17751-2.5	7587-2.5S	17743-2.5	7587-2.5-2	7595-2.5	8050-400C	38751-2.5-15	38751-2.5-30	38757-2.5
M3x0.5	17751-3	7587-3S	17743-3	7587-3-2	7595-3	8050-400C	38751-3-15	38751-3-30	38757-3
M4x0.7	17751-4	7587-4S	17743-4	7587-4-2	7595-4	8050-400C	38751-4-15	38751-4-30	38757-4
M5x0.8	17751-5	7587-5S	17743-5	7587-5-2	7595-5	8050-400C	38751-5-15	38751-5-30	38757-5
M6x1.0	17751-6	7587-6S	17743-6	7587-6-2	7595-6	8050-400C	38751-6-15	38751-6-30	38757-6

* An electronic driver requires a power supply, part number 8050-50.

** Includes blade, spring and pin.

(†) Gage style tools must be used with electronic tool. Handle must be removed prior to use with electronic or battery operated drivers.

Front End Assembly



Front End Assembly Dimensions

Nominal Thread Size	A Nose Diameter	B Body Diameter	C Prewinder Tip Length	D Prewinder Length
M2.5	0.250	0.375	0.095	1.375
M3	0.281	0.375	0.103	1.375
M4	0.344	0.500	0.139	1.375
M5	0.375	0.500	0.157	1.500
M6	0.422	0.625	0.192	1.625

Installation mandrel w/handle assembly



Installation mandrel only



Adjusting/removal tool (shown w/o handle)

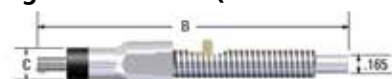

Installation Tool Dimensions

Nominal Thread Size	A Overall Length (reference)	B Mandrel Length	C Spinner Diameter
M2.5	5.063	2.716	0.240
M3	5.125	2.705	0.250
M4	5.312	3.985	0.360
M5	5.500	3.094	0.380
M6	5.500	3.094	0.433

Note: Installation mandrel and adjusting/removal tool designed for use with both handle and electronic tool.

TANGED INSERTS, TOOL & TAP SELECTION GUIDE

Nominal Thread Size	Hand Installation Tool	Pneumatic Installation Tool	Tang Break Off Tool	Removal Tool	Straight Flute				Spiral Point		High Spiral Flute	
					Plug		Bottoming		Plug		Bottoming	
					3B	2B	3B	2B	3B	2B	3B	2B
UNIFIED COARSE THREAD (UNC) ; (FREE RUNNING & SCREW-LOCKING)												
2-56	551-02	8551-02	3695-02	1227-02	02CPB	02CPA	02CBB	02CBA	02CSB	02CSA	5905-02	6905-02
4-40	7551-04	8551-04	3695-04	1227-06	04CPB	04CPA	04CBB	04CBA	04CSB	04CSA	5905-04	6905-04
6-32	7551-06	8551-06	3695-06	1227-06	06CPB	06CPA	06CBB	06CBA	06CSB	06CSA	5905-06	6905-06
8-32	7551-2	8551-2	3695-2	1227-06	2CPB	2CPA	2CBB	2CBA	2CSB	2CSA	5905-2	6905-2
10-24	7551-3	8551-3	3695-3	1227-6	3CPB	3CPA	3CBB	3CBA	3CSB	3CSA	5905-3	6905-3
1/4-20	7551-4	8551-4	3695-4	1227-6	4CPB	4CPA	4CBB	4CBA	4CSB	4CSA	5905-4	6905-4
5/16-18	7551-5	8251-5	3695-5	1227-6	5CPB	5CPA	5CBB	5CBA	5CSB	5CSA	5905-5	6905-5
3/8-16	7551-6	8251-6	3695-6	1227-16	6CPB	6CPA	6CBB	6CBA	6CSB	6CSA	5905-6	6905-6
7/16-14	7551-7	8251-7	3695-7	1227-16	7CPB	7CPA	7CBB	7CBA	7CSB	7CSA	5905-7	6905-7
1/2-20	7552-8	8252-8	3692-8	1227-16	8FPB	8FPA	8FBB	8FBA	8FSB	8FSA	5906-8	6906-8
9/16-12	3724-9		Pliers	1227-16	187-9	38187-9	4187-9	43187-9				
5/8-11	3724-10		Pliers	1227-16	8187-10	18187-10	10187-10	20187-10				
3/4-10	3724-12		Pliers	1227-16	8187-12	18187-12	10187-12	20187-12				
7/8-9	3724-14		Pliers	1227-16	8187-14	18187-14	10187-14	20187-14				
1-8	3724-16		Pliers	1227-16	8187-16	18187-16	10187-16	20187-16				
1-1/8-7	3724-18		Pliers	1227-24	8187-18	18187-18	10187-18	20187-18				
1-1/4-7	3724-20		Pliers	1227-24	8187-20	18187-20	10187-20	20187-20				
1-3/8-6	3724-22		Pliers	1227-24	8187-22	18187-22	10187-22	20187-22				
1-1/2-6	3724-24		Pliers	1227-24	8187-24	18187-24	10187-24	20187-24				
UNIFIED FINE THREAD (UNF) ; (FREE RUNNING & SCREW-LOCKING)												
2-64	7552-02		3695-02	1227-02	02FPB	02FPA	02FBB	02FBA	02FSB	02FSA	5906-02	6906-02
3-56	7552-03		3695-02	1227-06	03FPB	03FPA	03FBB	03FBA	03FSB	03FSA	5906-03	6906-03
4-48	7552-04		3695-04	1227-06	04FPB	04FPA	04FBB	04FBA	04FSB	04FSA	5906-04	6906-04
6-40	7552-06	8552-06	3695-06	1227-06	06FPB	06FPA	06FBB	06FBA	06FSB	06FSA	5906-06	6906-06
8-36	7552-2		3695-2	1227-06	2FPB	2FPA	2FBB	2FBA	2FSB	2FSA	5906-2	6906-2
10-32	7552-3	8552-3	3695-3	1227-6	3FPB	3FPA	3FBB	3FBA	3FSB	3FSA	5906-3	6906-3
1/4-28	7552-4	8552-4	3695-4	1227-6	4FPB	4FPA	4FBB	4FBA	4FSB	4FSA	5906-4	6906-4
5/16-24	7552-5	8251-5	3692-5	1227-6	5FPB	5FPA	5FBB	5FBA	5FSB	5FSA	5906-5	6906-5
3/8-24	7552-6	8251-6	3692-6	1227-6	6FPB	6FPA	6FBB	6FBA	6FSB	6FSA	5906-6	6906-6
7/16-20	7552-7	8251-7	3692-7	1227-16	7FPB	7FPA	7FBB	7FBA	7FSB	7FSA	5906-7	6906-7
1/2-20	7552-8	8252-8	3692-8	1227-16	8FPB	8FPA	8FBB	8FBA	8FSB	8FSA	5906-8	6906-8
9/16-18	535-9		Pliers	1227-16	38193-9	18193-9	43193-9	20193-9				
5/8-18	535-10		Pliers	1227-16	8193-10	18193-10	10193-10	20193-10				
3/4-16	535-12		Pliers	1227-16	8193-12	18193-12	10193-12	20193-12				
7/8-14	535-14		Pliers	1227-16	8193-14	18193-14	10193-14	20193-14				
1-14	535-16		Pliers	1227-16	8193-16	18193-16	10193-16	20193-16				
1-12	535-161		Pliers	1227-16	8193-161	18193-161	10193-161	20193-161				
1-1/8-12	535-18		Pliers	1227-24	8193-18	18193-18	10193-18	20193-18				
1-1/4-12	535-20		Pliers	1227-24	8193-20	18193-20	10193-20	20193-20				

TANGED INSERTS, TOOL & TAP SELECTION GUIDE

					Straight Flute				Spiral Point		High Spiral Flute	
					Plug		Bottoming		Plug		Bottoming	
					4H5H	5H	4H5H	5H	4H5H	5H	4H5H	5H
Nominal Thread Size	Hand Installation Tool	Pneumatic Installation Tool	Tang Break Off Tool	Removal Tool								
METRIC COARSE (FREE RUNNING & SCREW-LOCKING)												
M2x0.4	7751-2		4238-2	1227-01	4687-2	2087-2	4693-2	2093-2	4863-2	4763-2	5081-2	4681-2
M2.5x0.45	7751-2.5	8751-2.5	4238-2.2	1227-06	4687-2.5	2087-2.5	4693-2.5	2093-2.5	4863-2.5	4763-2.5	5081-2.5	4681-2.5
M3x0.5	7751-3	8751-3	4238-3	1227-06	4687-3	2087-3	4693-3	2093-3	4863-3	4763-3	5081-3	4681-3
M3.5x0.6	7751-3.5	8751-3.5	4238-3	1227-06	4687-3.5	2087-3.5	4693-3.5	2093-3.5	4863-3.5	4763-3.5	5081-3.5	4681-3.5
M4x0.7	7751-4	8751-4	4238-4	1227-06	4687-4	2087-4	4693-4	2093-4	4863-4	4763-4	5081-4	4681-4
M5x0.8	7751-5	8751-5	4238-5	1227-6	4687-5	2087-5	4693-5	2093-5	4863-5	4763-5	5081-5	4681-5
M6x1	7751-6	8751-6	4238-6	1227-6	4687-6	2087-6	4693-6	2093-6	4863-6	4763-6	5081-6	4681-6
M7x1	7751-7	8751-7	4238-7	1227-6	4687-7	2087-7	4693-7	2093-7	4863-7	4763-7	5081-7	4681-7
M8x1.25	7751-8	8751-8	4238-8	1227-6	4687-8	2087-8	4693-8	2093-8	4863-8	4763-8	5081-8	4681-8
M10x1.5	7751-10	8751-10	4238-10	1227-6	4687-10	2087-10	4693-10	2093-10	4863-10	4763-10	5081-10	4681-10
M12x1.75	7751-12	8751-12	4238-12	1227-16	4687-12	2087-12	4693-12	2093-12	4863-12	4763-12	5081-12	4681-12
M14x2	7751-14		Pliers	1227-16	4687-14	2087-14	4693-14	2093-14				
M16x2	7751-16		Pliers	1227-16	4687-16	2087-16	4693-16	2093-16				
M18x2.5	7751-18		Pliers	1227-16	4687-18	2087-18	4693-18	2093-18				
M20x2.5	7751-20		Pliers	1227-16	4687-20	2087-20	4693-20	2093-20				
M22x2.5	7751-22		Pliers	1227-16	4687-22	2087-22	4693-22	2093-22				
M24x3	7751-24		Pliers	1227-16	4687-24	2087-24	4693-24	2093-24				
M27x3	7751-27		Pliers	1227-24	4687-27	2087-27	4693-27	2093-27				
M30x3.5	7751-30		Pliers	1227-24	4687-30	2087-30	4693-30	2093-30				
M33x3.5	7751-33		Pliers	1227-24	4687-33	2087-33	4693-33	2093-33				
M36x4	7751-36		Pliers	1227-24	4687-36	2087-36	4693-36	2093-36				
M39x4	7751-39		Pliers	1227-24	4687-39	2087-39	4693-39	2093-39				
METRIC FINE (FREE RUNNING & SCREW-LOCKING)												
M8x1	7755-8	8755-8	4238-8	1227-6	5484-8	4984-8	5486-8	4986-8	4864-8	4764-8	5066-8	4666-8
M10x1	7755-10	8755-10	4238-10	1227-6	5484-10	4984-10	5486-10	4986-10	4864-10	4764-10	5066-10	4666-10
M10x1.25	7756-10	8756-10	4238-10	1227-6	5444-10	4944-10	5445-10	4945-10	4865-10	4765-10	5067-10	4667-10
M12x1.25	7756-12	8756-12	4238-12	1227-16	5444-12	4944-12	5445-12	4945-12	4865-12	4765-12	5067-12	4667-12
M14x1.5	7753-14		Pliers	1227-16	5476-14	4976-14	5477-14	4977-14				
M16x1.5	7753-16		Pliers	1227-16	5476-16	4976-16	5477-16	4977-16				
M18x1.5	7753-18		Pliers	1227-16	5476-18	4976-18	5477-18	4977-18				
M20x1.5	7753-20		Pliers	1227-16	5476-20	4976-20	5477-20	4977-20				
M22x1.5	7753-22		Pliers	1227-16	5476-22	4976-22	5477-22	4977-22				
M18x2	7754-18		Pliers	1227-16	5490-18	4990-18	5492-18	4992-18				
M20x2	7754-20		Pliers	1227-16	5490-20	4990-20	5492-20	4992-20				
M22x2	7754-22		Pliers	1227-16	5490-22	4990-22	5492-22	4992-22				
M18x2	7754-18		Pliers	1227-16	5490-18	4990-18	5492-18	4992-18				
M20x2	7754-20		Pliers	1227-16	5490-20	4990-20	5492-20	4992-20				
M22x2	7754-22		Pliers	1227-16	5490-22	4990-22	5492-22	4992-22				
M24x2	7754-24		Pliers	1227-16	5490-24	4990-24	5492-24	4992-24				
M27x2	7754-27		Pliers	1227-24	5490-27	4990-27	5492-27	4992-27				
M30x2	7754-30		Pliers	1227-24	5490-30	4990-30	5492-30	4992-30				
M33x2	7754-33		Pliers	1227-24	5490-33	4990-33	5492-33	4992-33				
M36x2	7754-36		Pliers	1227-24	5490-36	4990-36	5492-36	4992-36				
M39x2	7754-39		Pliers	1227-24	5490-39	4990-39	5492-39	4992-39				
M36x3	7752-36		Pliers	1227-24	5496-36	4996-36	5497-36	4997-36				
M39x3	7752-39		Pliers	1227-24	5496-39	4996-39	5497-39	4997-39				

HeliCoil® Thread Repair Kits & Master Sets

Heli-Coil inserts are available in thread repair kits and sets for repairing tapped holes which have been stripped or damaged due to wear, corrosion and over-torque. They are available in inch, metric, spark plug and pipe thread series. All kits have a quantity of inserts, the proper size drill, high speed steel Heli-Coil tap and an installation tool. The Professional Kits*



(shown in **bold** type) also includes a tang removal tool and quantities of three lengths of inserts.



PROFESSIONAL KITS

Nominal Thread Size	Kit Part No.	Inserts Per Kit
UNIFIED COARSE THREAD (UNC)		
4-40	5401-04	36*
5-40	5401-05	36*
6-32	5401-06	36*
8-32	5401-2	36*
10-24	5401-3	36*
12-24	5401-1	36*
1/4-20	5401-4	36*
5/16-18	5401-5	36*
3/8-16	5401-6	18*
7/16-14	5401-7	18*
1/2-13	5401-8	18*
9/16-12	5401-9	6
5/8-11	5401-10	6
3/4-10	5401-12	4
7/8-9	5521-14	6
1-8	5521-16	6
1-1/8-7	5521-18	5
1-1/4-7	5521-20	4
1-3/8-6	5521-22	4
1-1/2-6	5521-24	4

UNIFIED FINE THREAD (UNF)		
Nominal Thread Size	Kit Part No.	Inserts Per Kit
6-40	5402-06	36*
8-36	5402-2	36*
10-32	5402-3	36*
1/4-28	5402-4	36*
5/16-24	5402-5	36*
3/8-24	5402-6	18*
7/16-20	5402-7	18*
1/2-20	5402-8	18*
9/16-18	5402-9	6
5/8-18	5402-10	6
3/4-16	5402-12	4
7/8-14	5528-14	6
1-14	5528-16	6
1-12	5528-161	6
1-1/8-12	5528-18	5
1-1/4-12	5528-20	4
1-3/8-12	5528-22	4
1-1/2-12	5528-24	4

* The total quantity of inserts in the Professional Kits represents 3 lengths.

PROFESSIONAL KITS

Nominal Thread Size	Kit Part No.	Inserts Per Kit
METRIC COARSE		
M3x0.5	5403-3	36*
M3.5x0.6	5403-3.5	36*
M4x0.7	5403-4	18*
M5x0.8	5403-5	18*
M6x1	5403-6	18*
M7x1	5403-7	18*
M8x1.25	5403-8	18*
M9x1.25	5403-9	12
M10x1.5	5403-10	18*
M11x1.5	5403-11	6
M12x1.75	5403-12	18*
M14x2	5403-14	12
M16x2	5403-16	6
M18x2.5	5403-18	6
M20x2.5	5403-20	4

METRIC FINE		
Nominal Thread Size	Kit Part No.	Inserts Per Kit
M8x1	5404-8	18*
M10x1	5404-10	18*
M10x1.25	5405-10	18*
M12x1.25	5405-12	18*
M12x1.5	5406-12	18*
M14x1.5	5406-14	6
M16x1.5	5406-16	6
M18x1.5	5406-18	6

* The total quantity of inserts in the Professional Kits represents 3 lengths.



MASTER THREAD REPAIR SETS

Type	Part No.	Insert sizes included in set
Inch Coarse	4934	1/4-20, 5/16-18, 3/8-16, 7/16-14, 1/2-13, 5/8-11
Inch Fine	4936	10-32, 1/4-28, 5/16-24, 3/8-24, 7/16-20, 1/2-20
Metric	4937-125	M5x0.8, M6x1, M8x1.25, M10x1.25
Metric	4937-150	M5x0.8, M6x1, M8x1.25, M10x1.5

All sets contain a drill, tap, tool and inserts for each size listed above.

SPARK PLUG KITS

Nominal Thread Size	Kit Part No.	Reach	Inserts Per Kit
10-1.0mm	5523-10	1/2	24
12-1.25mm	5523-12	1/2	12
		3/4	12
		3/8	6
14-1.25mm	5523-14	7/16	6
		1/2	6
		3/4	6
18-1.50mm	5523-18	1/2	24
		7/8-18	550
M14x1.25*	5408-14	Short	6
		Normal	6
		Long	6

*Sav-A-Thread®

Note: Do not use Heli-Coil wire inserts to repair taper seat plug ports.



PIPE THREAD KITS

Nominal Thread Size	Kit Part No.	Inserts Per Kit
1/8-27	5407-2	12
1/4-18	5407-4	12
3/8-18	5407-6	10
1/2-14	5407-8	10
3/4-14	5407-12	10
1-11-1/2	5407-16	6

Powerful Brands. Breakthrough Solutions.

At STANLEY, Engineered Fastening we believe in seeking ways to serve our customers better. We create the future by anticipating our customers needs. Through diversifying our product lines, creating unique assembly technologies and offering a breadth of service to meet the demands of industry worldwide, STANLEY Engineered Fastening provides technological solutions to over 100 different industries.



Avdel®

Avdel® has been producing assembly systems since 1936 and offers a comprehensive range of fasteners and tooling. [More Info>](#)



POP®

From 2mm micro rivets to 1/4" structural rivets, POP blind rivets meet the needs of multiple markets. [More Info>](#)



Dodge®

With a focus on high-quality threaded inserts for plastics products, Dodge has been a leader in the fastening market since the 1950s. [More Info>](#)



STANLEY Assembly Technologies

STANLEY Assembly Technologies supplies production solutions to the global assembly market. [More Info>](#)



Gripco®

Gripco® has been providing quality nut and threaded assembled products since 1904. [More Info>](#)



Spirallock®

Spirallock is a technologically superior fastening system ideally suited for threaded joint applications subjected to heavy shock and vibration. [More Info>](#)



Heli-Coil®

Based on a long history that began in the aerospace industry, Heli-Coil offers a vast range of high-quality. [More Info>](#)



Tucker®

A one-sided drawn-arc welding process is the foundation of the Tucker No-Hole assembly solution. [More Info>](#)



iForm®

iForm® continues a proud heritage since 1969 and represents over 40 years of creative threaded fastener application engineering. [More Info>](#)



Warren®

Whether it's plastic, metal, or a combination of the two, Warren can design a product that will suit your environment. [More Info>](#)

STANLEY®

Engineered Fastening

Helicoil®



STANLEY Engineered Fastening, a Stanley Black & Decker Inc. Company has been revolutionizing fastening and assembly technologies for a variety of industries for more than 40 years.

For more information, please visit our website
www.StanleyEngineeredFastening.com

Quick Links:

- ▶ Our locations
<http://www.stanleyengineeredfastening.com/contact/global-locations>
- ▶ Request Information
<http://www.stanleyengineeredfastening.com/econtact/request-information>
- ▶ Resource Center
<http://www.stanleyengineeredfastening.com/resource-center>

